

AGES 8+
ITEM NO. 9001

27MHz

 **CAUTION - ELECTRIC TOY:**

NOT RECOMMENDED FOR CHILDREN UNDER 4 YEARS OF AGE. AS WITH ALL ELECTRIC PRODUCTS, PRECAUTIONS SHOULD BE OBSERVED DURING HANDLING AND USE TO PREVENT ELECTRIC SHOCK. INPUT: AC100-240V, 50/60 HZ OUTPUT: DC6V 3.5A



CHIMPANZEE

USER'S MANUAL

Introduction

The Chimpanzee, our closest animal relative, is brought to life in this state-of-the-art animatronic head. He is highly communicative, fully interactive and has four distinct moods. He's so real, it's unreal!

Be sure to read this manual carefully for a complete understanding of the many features of this Chimpanzee.

This package contains: 1 x Chimpanzee
 1 x Controller (with detachable antenna)
 1 x a.c/ d.c Adaptor
 (optional)



Chimpanzee



Controller

Table of Contents

Battery Information	p.4-5
Controller Overview	p.6-7
Chimpanzee Overview	p.8
Alive Mode	p.9
Moods	p.9
Touch Sensors	p.10
Infrared Vision Systems	p.11
Stereo Hearing	p.12
Direct Control	p.13
Joysticks and Toggles Left.....	p.14
 Right.....	p.15
Program Mode	p.16
Guard Mode	p.17
Demo Mode	p.17
Sleep Mode	p.17

Battery Information

Battery Requirements

Chimpanzee Body

Your Chimpanzee is powered by 4 x 1.5V "D" size batteries (not included). Recommended to use alkaline batteries.

Alternatively, the Chimpanzee can be powered by an Output 6V d.c, 3.5 amperes, center positive adaptor (if included).

Bottom View of the Chimpanzee

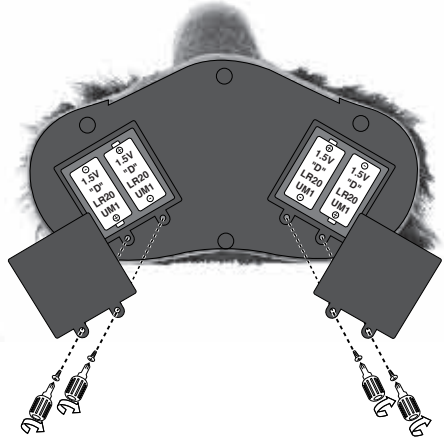

Controller

Your Chimpanzee's Controller is powered by 1 x 9V battery (not included).

FCC Note:

The unique antenna provided has been authorised for use with this equipment. Installation of any other antenna is not authorised under FCC regulations.

The manufacturer is not responsible for any radio or TV interference caused by unauthorised modification of the product.

Back view of the Remote Controller

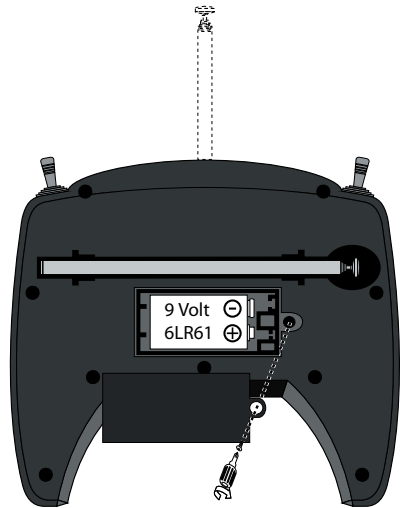

Body Batteries

The Chimpanzee does not issue a warning about weak batteries. You may notice that his movements become slower when his batteries need changing.

Controller Battery

If the Chimpanzee is not responding well to controller commands, you may need to replace the controller battery.

Battery Information

Battery Installation: Chimpanzee and Remote Controller

1. Before installing or changing batteries, ensure the equipments ON / OFF buttons are in the OFF position.
2. Remove the battery compartment covers using a Phillips or crosshead screwdriver (not included).
3. Insert the batteries (not included) into the Chimpanzee and the Controller as shown in the diagrams.
4. Replace the battery compartment covers and screws.

Attention: important battery information

- Use only fresh batteries of the required size and recommended type.
- Do not mix old and new batteries, different types of batteries (Standard (Carbon zinc), alkaline, or rechargeable), or rechargeable batteries of different capacities.
- Remove rechargeable batteries from the toy before recharging them.
- Rechargeable batteries are only to be charged under adult supervision.
- Please respect the correct polarity, (+) and (-).
- Do not try to charge non-rechargeable batteries.
- Do not throw batteries into the fire.
- Replace all batteries of the same type/brand at the same time.
- The supply terminals are not to be short circuited.
- Remove exhausted batteries from the toy.
- Batteries should be replaced by adults.
- Remove batteries if the toy is not going to be played with for some time.
- Retain packaging as it contains important information.

a.c/ d.c ADAPTOR (If included)

The Chimpanzee can be powered by an Output 6V d.c, 3.5 Amperes, center positive adaptor. Use the adaptor included in this pack, otherwise purchase one of the required power voltage. (The toy must only be used with the recommended transformer). To operate the Chimpanzee with an adaptor, simply turn the ON/ OFF switch OFF, insert the jack into the d.c socket in the back of the Chimpanzee's head and plug the adaptor into the mains socket. Now turn the Chimpanzee's ON/ OFF switch to the ON position. Toys liable to be cleaned with liquid are to be disconnected from the transformer.

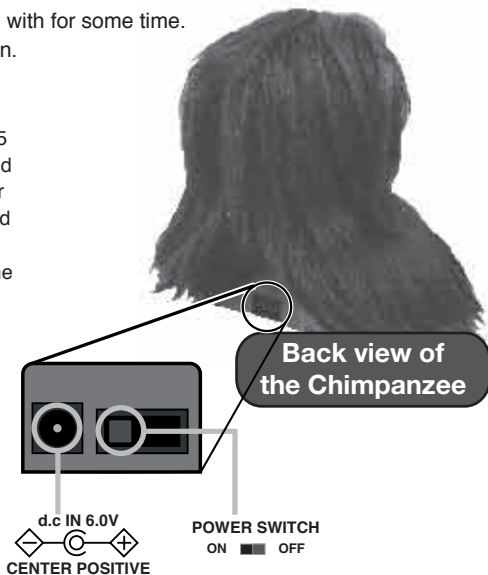
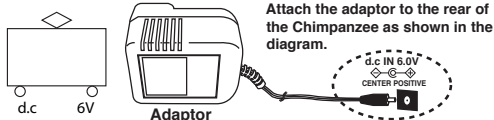

Important Safety Notice:

- Examine the a.c/ d.c adaptor regularly for damage to the cord, plug, enclosure and other parts, and that, in the event of such damage, the toy must not be used with the adaptor until the damage has been repaired.
- The a.c/ d.c adaptor is not a toy.
- The Chimpanzee may generate some abnormal motion or sound if you directly change the power source (from batteries to adaptor and vice versa) without turning the ON/ OFF switch to OFF first. After changing the power source, please turn the ON/ OFF switch to the ON position.
- The toy is not intended for children under 3 years old.

Controller Overview

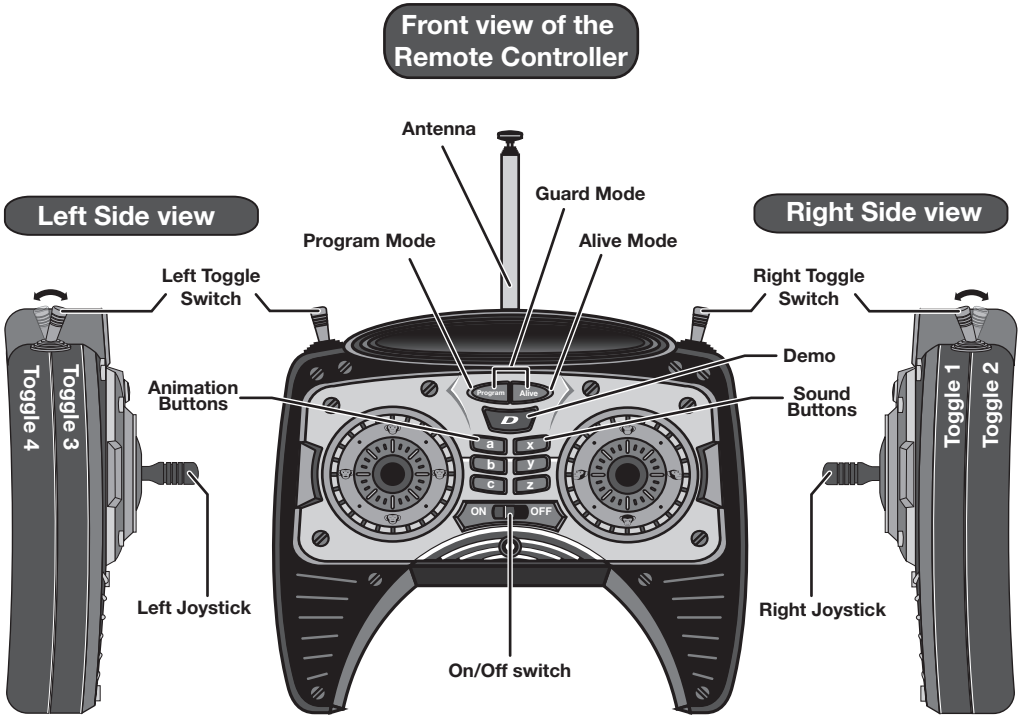

Chimpanzee Controller Overview

To turn on the controller use the ON / OFF switch. For more detailed instructions refer to Direct Control on p.13.

Program Button

This button allows the Chimpanzee to be programmed (See Program Mode p.16).

Alive Button

Put the Chimpanzee into Alive Mode (see p.9).

Demo Button

Push this button and the Chimpanzee will perform a random sequence of animations.

Controller Overview

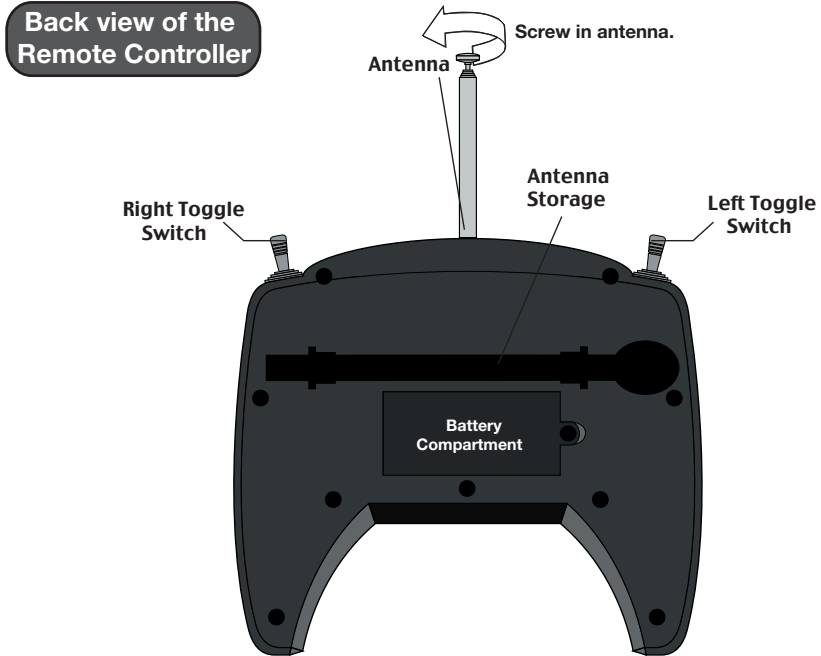

Attaching the Antenna

The antenna is stored in the back of the Chimpanzee Controller to prevent damage.

To attach the antenna, simply remove from its storage slot, insert into the hole situated on the top of the Controller (between the two toggle switches), and screw into place; as illustrated above.

When not in use, unscrew the antenna and place back in the antenna storage slot.

Toggle Switches

These switches change the function of the joysticks, animations and sound buttons.

Animation and Sound Buttons

Use these buttons to make the Chimpanzee perform animations and sounds on demand.

Joysticks

Control the Chimpanzee's movements directly with the joysticks.

Control Distance

The Controller has a control distance up to 20 feet.

Chimpanzee Overview

Turning ON the Chimpanzee

To turn ON the Chimpanzee, slide the switch located at the back of his neck to the ON position. He will perform an animation, starting in Curious Mood. He is in Alive Mode and will react to sensor input.

To deactivate the Chimpanzee, simply turn him OFF using the same switch. He will lose his current mood settings and the user program memory.

Full Reset

If you wish to reset the Chimpanzee to his default settings, turn him OFF and then ON again (see ON / OFF switch position on p.5).

Warning

Do not rub the face. Otherwise, the color on the skin would be removed.

Do not hold the Chimpanzee by the hair only. The hair is not designed to support the overall weight of Chimpanzee.

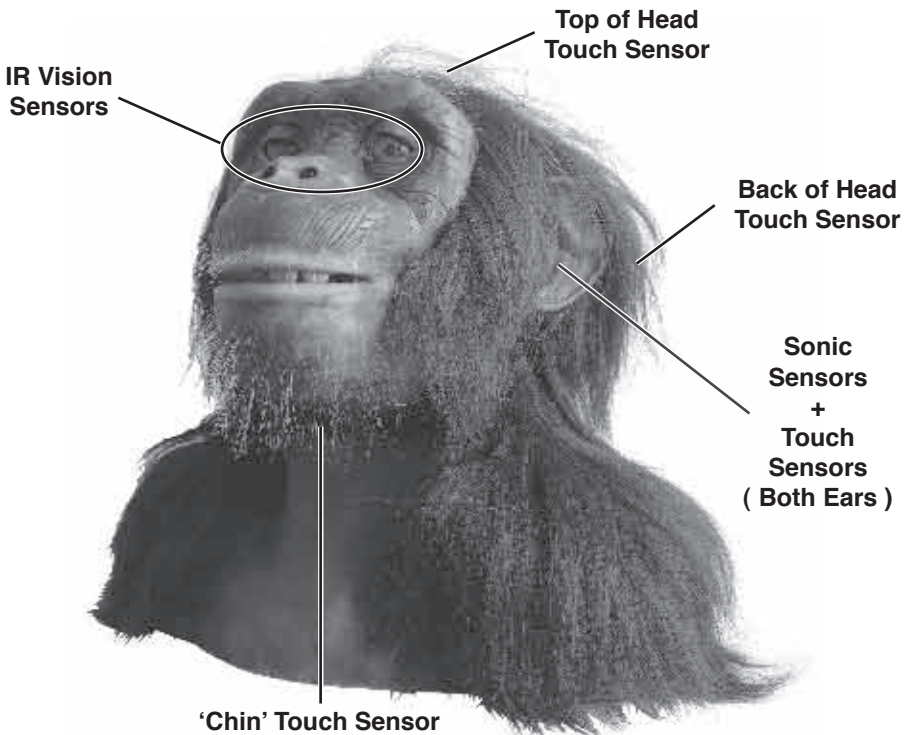

Alive Mode

In Alive Mode, the Chimpanzee will react to user interaction through his sensors with different animations depending on his mood.

When he is first turned on, he is in his default mood - Curious. When returning to Alive Mode from Direct Control Mode, the Chimpanzee will start in the mood he was last performing (see Moods below).

NOTE: The Chimpanzee's sensors only work in Alive Mode and Guard Mode.

- While in Alive Mode the Chimpanzee will perform little blinks and eye movements even when not played with.
- He will leave Alive Mode if any of the buttons (except Alive Mode) or joysticks on the controller are touched.
- He will re-enter Alive Mode if he is given no controller commands for approximately four minutes or if the Alive button on the controller is pressed and held for around 2.5 seconds.

Moods

The Chimpanzee has four moods which determine his reactions to user interaction. Whenever you interact with the Chimpanzee in Alive Mode through his sensors, you will influence his moods.

The Chimpanzee's four moods are:

Curious (default mood)
Happy
Fearful
Angry

The Chimpanzee's emotions change as a direct result of how he is treated. In most cases a tap on the back of his head or a flick to the ears will make him angry, flinches and sounds will make him more fearful and a stroke, pat, or tickle will make him happy. Leave him alone for a while and he will eventually return to Curious mood (this is his default mode).

Touch Sensors

There are 5 touch sensors on the Chimpanzee, one in each ear, one under his chin, one on the back and one on the top of his head (see Chimpanzee Overview on p.8).

Ears

The Chimpanzee has a touch sensor located in each ear. These sensors react to a light flick.

Chin

You can gently tickle or tap the area under the Chimpanzee's chin and he will react in a friendly way, but this can vary depending on his current mood state.

Head

There are two sensors located on the chimpanzee's head; one is on the top and one is on the back of his head. There are four different ways of eliciting a reaction from the Chimpanzee with these sensors:

1. Tap (single touch) the top of the Chimpanzee's head.
2. Pat (repeated rapid taps) the top of his head.
3. Tap (single touch) the back of the Chimpanzee's head.
4. Stroke (top to back - rapidly) his head from top to back.

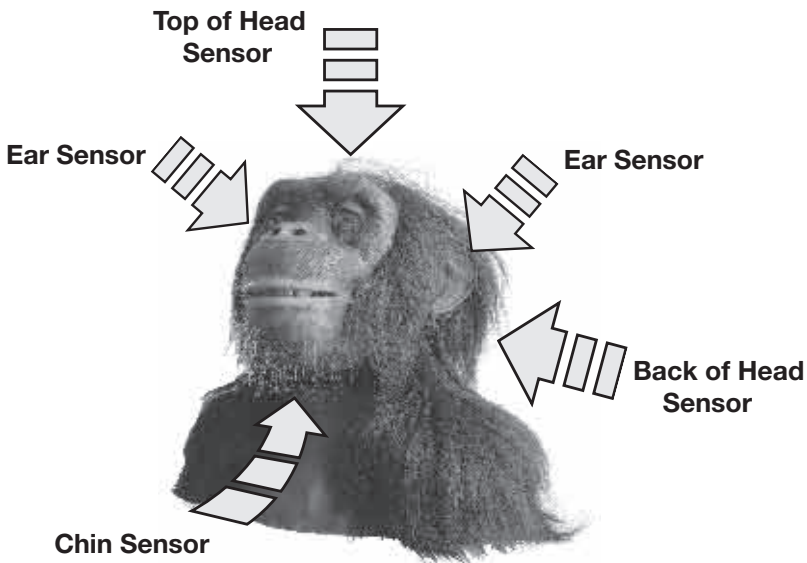

Infrared Vision System

The Chimpanzee's Infrared Vision System enables him to detect movement in front of him. His vision is ON only when he is not moving or making a sound.

Tracking

The Vision System reacts best to movement in the area just in front of his nose (see illustration below). The Chimpanzee will track objects in front of his face - Up, Down, Left, and Right.

When tracking an object the Chimpanzee will keep his vision locked on it until he loses sight of it. This will not affect his mood.

Flinch

Put something quickly in front of the Chimpanzee's face and he will react with a surprised response. This will affect his mood.

See Guard Mode (p.17) for further uses of the Chimpanzee's Vision System.

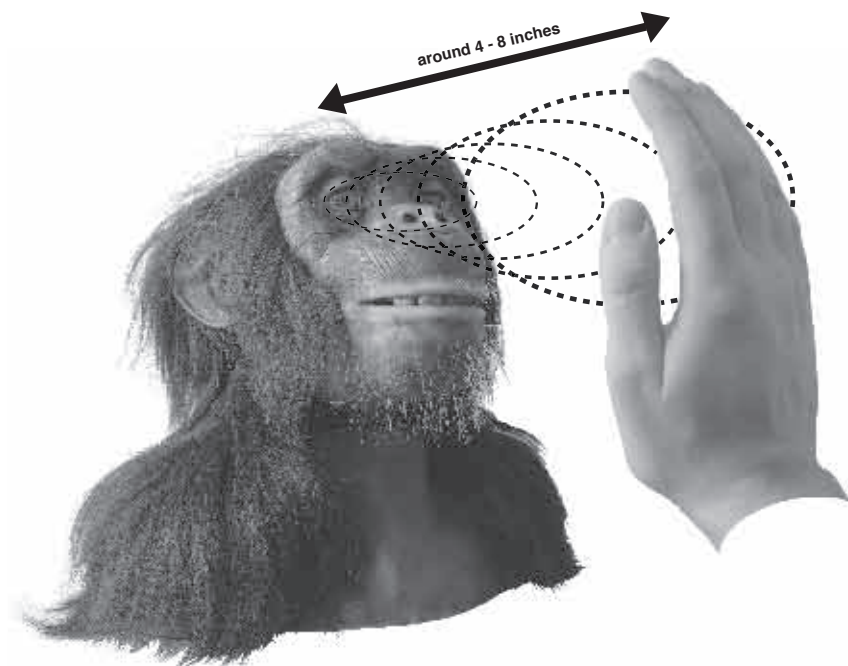

NOTE: The Chimpanzee's Infrared Vision works best at around 4-8 inches from his face. Infrared functions can be affected by bright sunlight, fluorescent and electronically dimmed lighting.

The Chimpanzee's vision is only ON in Alive Mode or Guard Mode.

Stereo Hearing

The Chimpanzee has a Stereo Sound Detection System which can detect sharp, loud sounds (like a clap) to his left, his right and directly ahead. He will only listen when he is not moving or making sound.

When he hears a sound, the Chimpanzee will respond with an animation. Responding to sounds will also influence his mood.



NOTE: The Chimpanzee's Stereo Hearing is only ON in Alive Mode or Guard Mode.

Direct Control

Direct Control of the Chimpanzee is activated by pressing any of the buttons on the controller (except the Alive button), or by moving the joysticks, automatically taking him out of Alive Mode.

Once in Direct Control Mode, the Chimpanzee is animated by using the following controller features:

Animation Buttons Sound Buttons Joysticks

All commands given using the joysticks or buttons have different operations, depending on the position of the Toggle Switches.

Animation and Sound Buttons

Animation Buttons



Pressing one of these buttons will make the Chimpanzee perform an animation determined by the mood selected (see Toggle Chart below).

Sound Buttons











By pressing one of these buttons, the Chimpanzee will “speak” in a way determined by the mood selected (see Toggle Chart below).

His mouth will animate while he makes sounds.

There is a toggle switch on each shoulder of the controller.

The Toggle Chart (right) illustrates the position of each toggle for the Chimpanzee’s 4 moods.

Right Toggle Position	Left Toggle Position	Mood Selected
 1	+  3	= Curious
 1	+  4	= Happy
 2	+  3	= Fearful
 2	+  4	= Angry

Left Joystick and Left Toggle

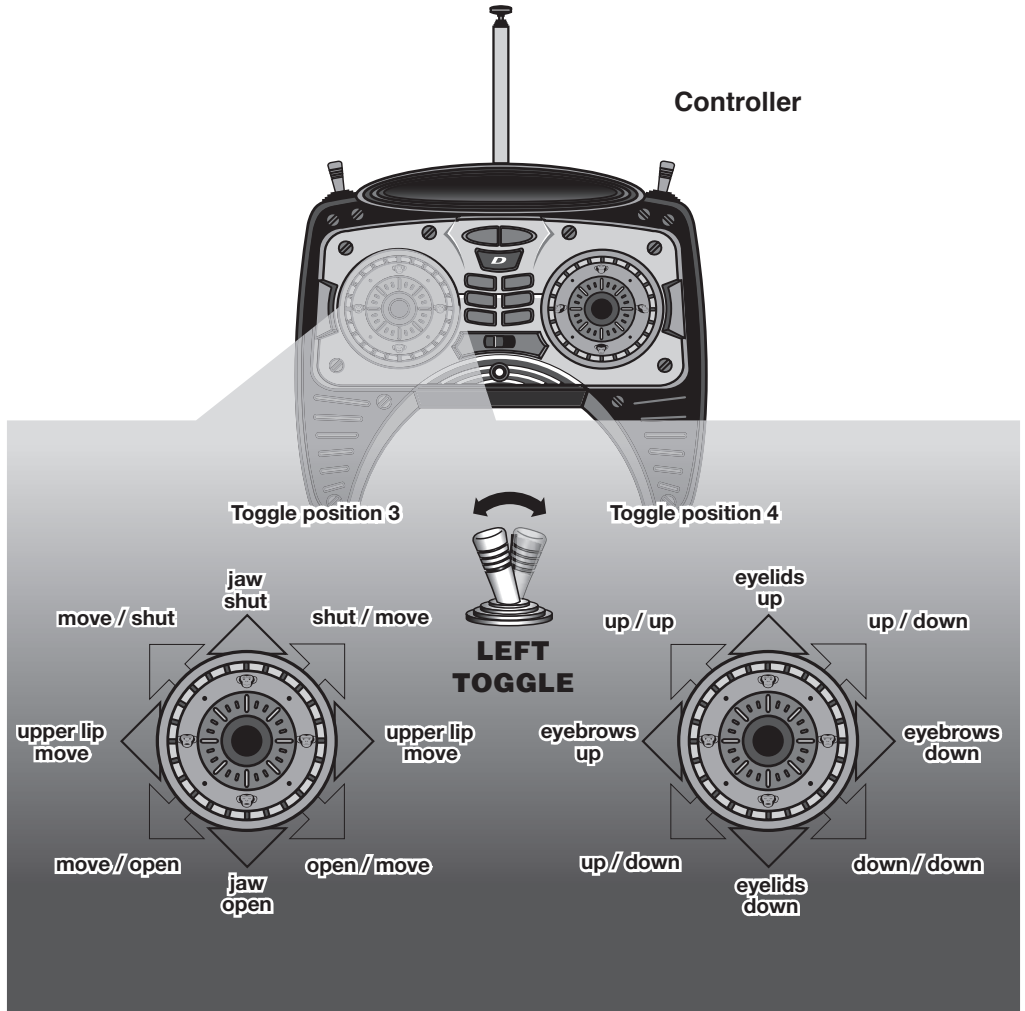

NOTE: When in Direct Control Mode the Chimpanzee's Touch Sensors are turned OFF.

Right Joystick and Right Toggle

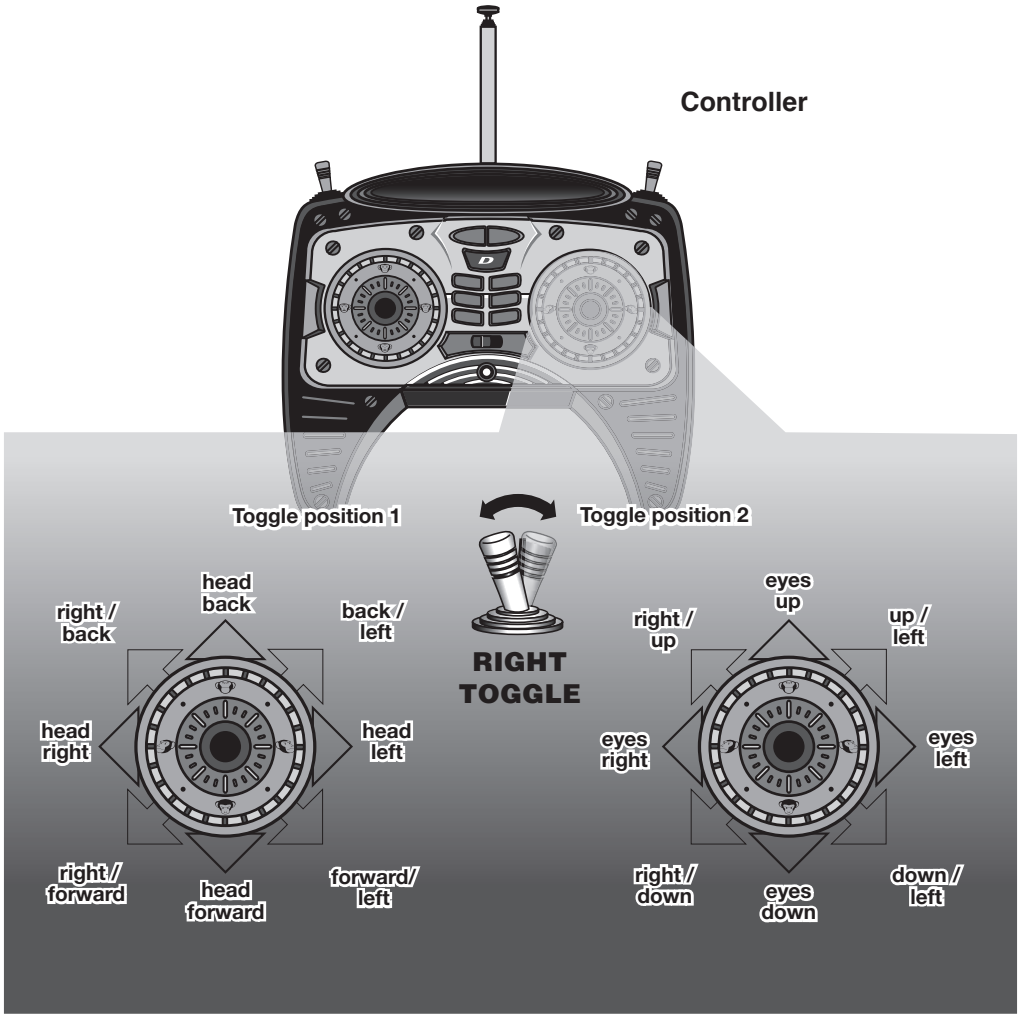

NOTE: Control the Chimpanzee as if he is your reflection in a mirror. 'Head Right' will turn his head to HIS right.

Program Mode

You can program a sequence of movements and sounds in Program Mode.

Entering Program Mode

To enter the Program Mode the user must hold the Program button for around 2.5 seconds, the Chimpanzee will “speak” to acknowledge Program Mode entry.

Using the joystick, the user can send commands to the Chimpanzee to perform a movement. The move is stored only after the joystick is released, or moved in another direction.

The amount of time that the joystick is held in a specific direction determines how far the Chimpanzee moves. When a joystick is moved in another direction, this is a new step in the program.

STORING A PROGRAM

You can program a maximum of 20 steps. By pressing a Sound button, it will be added into the sequence as a step.

End Program Mode by pressing the Program button again or programming all 20 steps.

A stored program can be played back at any time and in any mood, by pressing the Program button once. If there is nothing programmed, the Chimpanzee will remain stationary. If the user enters Program Mode when a program is already stored, that program will be overwritten.

Resetting Program Mode

To reset his Program Mode manually, enter Program Mode by holding the Program button for around 2.5 seconds. Holding the Program Mode button again for around 2.5 seconds will perform a reset. Press the button again to exit Program Mode.

Guard Mode

Pressing the Program button and the Alive button at the same time will put the Chimpanzee into Guard Mode. He will confirm this with a Sound and /or Motion.

In Guard Mode, the Chimpanzee will use his Vision Sensors and Stereo Sound Sensors to guard the area immediately around him. Occasionally the Chimpanzee will turn his head and look around.

Upon seeing or hearing something, Chimpanzee will perform a programmed routine - if there is no program in his memory then he will perform a random animation. He tracks movement but a flinch sets off the Guard Mode response.

After around 20 minutes he exits Guard Mode and the Chimpanzee goes into Sleep Mode, performing an animation before doing so.

To exit Guard Mode at any time, press and hold the Alive button for around 2.5 seconds.

Demo Mode

Pressing the Demo button makes the Chimpanzee perform a random sequence of 2 or 3 animations. After a Demo sequence, the Chimpanzee returns to whichever mode he was in previously.

Sleep Mode

When the Chimpanzee is in Direct Control Mode and has had no input for approximately 4 minutes he will go into Alive Mode.

When the Chimpanzee is in Alive Mode and has had no interaction for around 10 minutes he will Power Down.

To wake the Chimpanzee up, activate any of the Touch Sensors on his head (see p.10 for sensor positions).

SAFETY TIPS:

This device complies with Part 15 of the FCC Rules. Operation is subject to the following two conditions: (1) This device may not cause harmful interference, and (2) This device must accept any interference received, including interference that may cause undesired operation.

NOTE: This equipment has been tested and found to comply with the limits for a Class B digital device, pursuant to Part 15 of the FCC Rules. These limits are designed to provide reasonable protection against harmful interference in a residential installation. This equipment generates, uses and can radiate radio frequency energy and, if not installed and used in accordance with the instructions, may cause harmful interference to radio communications. However, there is no guarantee that there will be no interference to radio or television reception, which can be determined by turning the equipment off and on. The user is encouraged to try to correct the interference by one or more of the following measures:

- Reorient or relocate the receiving antenna.
- Increase the separation between the equipment and the receiver.
- Connect the equipment into an outlet on a circuit different from that to which the receiver is used.
- Consult the dealer or an experienced radio/TV technician for help.

WARNING: Changes or modifications to this unit not expressly approved by the party responsible for compliance could void the user's authority to operate the equipment.
Please keep these instructions as they contain important information.



We recommend that you retain our address for future reference.
Product and colors may vary.
PRINTED IN CHINA.

EL9001US02

Manufactured and distributed by
©2005 WowWee Ltd.
All Right Reserved.

WowWee (Asia Office)
Unit 301A-C, 92 Granville Rd.,
T.S.T. East, Hong Kong

WowWee (North American Office)
4480 Cote de Liesse, Suite 320,
T.M.R. Quebec, H4N 2R1, Canada
Consumer Hotline: 1-800-310-3033
www.wowwee.com