

TOPO OWNER'S MANUAL

FOR USE WITH
APPLE II+ AND APPLE IIe
COMPUTER SYSTEMS



©1983 by Androbot Inc.
101 East Daggett Drive
San Jose, California 95134
~~(408) 262-8676~~

FCC NOTICE

This equipment generates and uses radio frequency energy and if not installed and used properly, that is, in strict accordance with the manufacturer's instructions, may cause interference to radio and television reception. It has been type tested and found to comply with the limits for a Class B computing device in accordance with the specifications in Subpart J of Part 15 of FCC Rules, which are designed to provide reasonable protection against such interference in a residential installation. However, there is no guarantee that interference will not occur in a particular installation. If this equipment does cause interference to radio or television reception, which can be determined by turning the equipment off and on, the user is encouraged to try to correct the interference by one or more of the following measures:

- Reorient the receiving antenna.
- Relocate the computer with respect to the receiver.
- Move the computer away from the receiver.
- Plug the computer into a different outlet so that computer and receiver are on different branch circuits.

If necessary, the user should consult the dealer or an experienced radio/television technician for additional suggestions. The user may find the following booklet prepared by the Federal Communications Commission helpful:

"How to Identify and Resolve Radio-TV Interference Problems."

This booklet is available from the U.S. Government Printing Office, Washington, D.C. 20402. Stock No. 004-000-00345-4.

IMPORTANT SAFETY INSTRUCTIONS

READ ALL INSTRUCTIONS

TOPO is an electrically operated device. As with any such device, precautions should be taken while handling and using the product to avoid electrical shock. Service TOPO only when the robot is disconnected from the battery charger.

BATTERY INFORMATION

TOPO's batteries contain corrosive fluids and should be handled with care. As in all rechargeable batteries, explosive gases could be vented during charging or discharging, so use TOPO only in a well ventilated area and keep the robot away from any source of ignition.

Batteries should be recharged only by adults, and only with the battery charger supplied with the robot. Avoid any direct connection of the battery terminals that will cause the batteries to short out. Do not make direct contact between the positive and negative terminals, as this could cause high current to flow, creating heat and the possibility of fire.

Never charge the batteries in an upside-down position, and always keep them out of reach of children.

Observe these simple precautions and you should enjoy many months of service from TOPO's batteries.

SAVE THESE INSTRUCTIONS

Contents

	<u>Page</u>
Section 1	
INTRODUCTION.....	1
Introducing TOPO.....	1
TOPO General Description.....	2
What Do I Need to Use TOPO?.....	3
Section 2	
INSTALLATION.....	9
Unpacking TOPO.....	9
Charging TOPO's Batteries.....	12
Making TOPO Move Manually.....	14
Configuring the Serial Card.....	15
Installing the Base Communicator.....	16
Locating the Base Communicator.....	19
Copying the TopoSoft Diskette.....	20
Power-On Error Checking.....	22
A Message from TOPO.....	23
Section 3	
GETTING STARTED.....	25
About this Manual.....	25
Joystick Control.....	27
Simple Movement Commands.....	28
Making TOPO Talk.....	30
User-Defined Commands.....	32

Contents

	<u>Page</u>
Section 1	
INTRODUCTION.....	1
Introducing TOPO.....	1
TOPO General Description.....	2
What Do I Need to Use TOPO?.....	3
Section 2	
INSTALLATION.....	9
Unpacking TOPO.....	9
Charging TOPO's Batteries.....	12
Making TOPO Move Manually.....	14
Configuring the Serial Card.....	15
Installing the Base Communicator.....	16
Locating the Base Communicator.....	19
Copying the TopoSoft Diskette.....	20
Power-On Error Checking.....	22
A Message from TOPO.....	23
Section 3	
GETTING STARTED.....	25
About this Manual.....	25
Joystick Control.....	27
Simple Movement Commands.....	28
Making TOPO Talk.....	30
User-Defined Commands.....	32

Section 4

MOVING ON..... 35

- More on Movement..... 35
- Controlling TOPO's Speed..... 35
- Acceleration/Deceleration Ramp..... 36
- Curved Path Movement..... 37
- Interrupting a Movement Command..... 39
- Introducing a Delay While Moving..... 40
- Headswitch Uses and Commands..... 40
- Precision Position Control..... 41
- Resetting Movement/Speech Parameters. 42
- Saving Colon Definitions..... 42

Section 5

SPEECH..... 43

- About this Section..... 43
- Text-to-Speech Mode..... 46
- Controlling TOPO's Pitch and Volume... 47
- Controlling TOPO's Speech Rate..... 48
- Controlling TOPO's Intonation..... 49
- Delaying Commands During Speech..... 50
- Pronouncing Numbers..... 50
- Activating Stored Speech Commands... 51
- Pronouncing Words and Letters..... 52
- Pronouncing Symbols and Punctuation.. 52
- Resetting Speech Functions..... 54
- Better Speech with SAY"..... 54
- Phonetic Speech Mode..... 57
- Fine Tuning in Phonetic Mode..... 62
- Special Effects..... 66
- Foreign Languages..... 68

	<u>Page</u>
Section 6	
FOR PROGRAMMERS.....	71
Introduction.....	71
About TopoSoft.....	71
Additional TOPO Commands.....	73
Status Request Commands.....	73
More on Motion Control.....	76
Multiple TOPO Control.....	77
Appendix	
A TROUBLESHOOTING.....	A1
B TOPOSOFTE COMMAND SUMMARY.....	B1
C TOPOSOFTE 6502 ASSEMBLER.....	C1
D FORTH EDITOR COMMAND SUMMARY...	D1
E EXCEPTIONS TO MVP FORTH.....	E1
F CORRECTIONS TO STARTING FORTH..	F1
G SHORTENING TOPOSOFTE COMMANDS..	G1
H SPECIFICATIONS.....	H1

Figures & Tables

<u>Figure</u>	<u>Page</u>
1. TOPO/Computer Configuration.....	4
2. TOPO.....	5
3. Proper Way to Lift TOPO.....	11
4. TOPO Back Control Panel.....	12
5. TOPO Headswitch.....	14
6. Base Communicator.....	17
7. Computer/Base Communicator Cable Connection.....	18

Table

5-1 Spellings for Better Pronunciation.....	55
5-2 Phonetic Symbols for Speech Module.....	60
5-3 How to Lengthen Vowels in Phonetic Mode.	67

In 1950, science fiction author Isaac Asimov published a collection of earlier stories in a book called "I, Robot." In the introduction of this book, Asimov stated that the major manufacturer of robots would come into existence in 1982.

He was right about the date, but not about the company's name. Our name is Androbot Inc., and like Asimov's U.S. Robot and Mechanical Men, Inc., we came into existence in 1982. There is, however, a major difference between the two companies - we are real, and so are our products. Robots are no longer just science fiction.

So allow us to welcome you to a new era - the Age of Androbotics.

Although we have made every attempt to verify the accuracy of this document and accompanying software, we cannot assume any liability for errors or omissions. No warranty or other guarantee can be given as to the accuracy or suitability of this software for a particular purpose, nor can we be liable for any loss or damage arising from the use of this software.

Copyright Androbot Inc., 1983. All rights reserved. No part of this publication or accompanying software packages may be reproduced in whole or in part except for the making of backup copies of the software for the sole use of the purchaser. Unauthorized copying or transmitting of this copyrighted software in or on any medium is strictly prohibited.

Androbot products may be the subject of applications for Letters and Design patents. Infringement of the rights granted under these patents is expressly prohibited.

NOTE: Androbot Inc. copyrights extend to the appearance of TOPO. All rights reserved including display rights. TOPO may not be publicly displayed without the prior written permission of Androbot Inc. or one of its agents.

TOPO and TopoSoft are registered trademarks of Androbot Inc.

Apple, Apple II+ and Apple IIe are registered trademarks of Apple Computer, Inc.

ECHO and ECHO II are registered trademarks of Street Electronics Corporation.

SIGNATURE EDITION TOPO

Congratulations. You are the owner of a Signature Edition TOPO, one of the first 500 produced by Androbot, Inc. It bears an engraved plaque signed by TOPO's inventor, Nolan Bushnell.

In addition to all of TOPO's standard features and capabilities, your Signature Edition model is equipped with two storage compartments (one on each side, beneath the shoulder area), and footlights near the Andromotion wheels.

Opening TOPO's storage compartments is a snap. With your hands in the position shown below, gently press down with your thumbs until the latch opens and the panel swings down. Repeat the same hand motion when you are ready to close the latch.

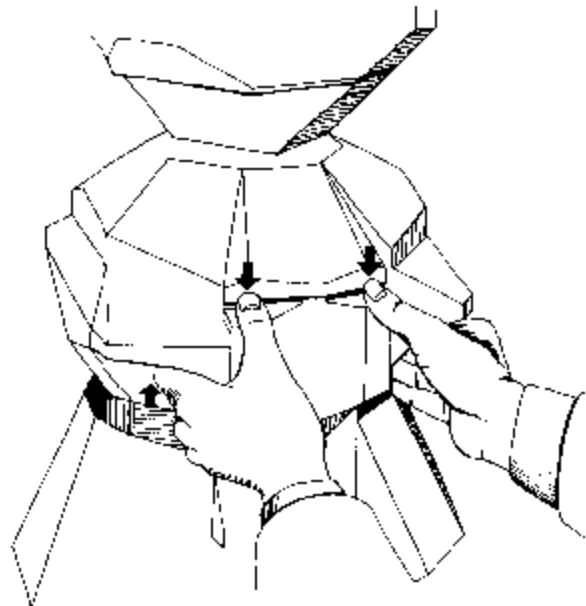

OPENING TOPO'S STORAGE COMPARTMENTS

The footlights on your Signature Edition TOPO, shown below, blink to indicate the direction of rotation for each wheel. When TOPO is stopped or is moving forward, the footlights in front of each wheel will be blinking. When TOPO is moving backward, the footlights in back of each wheel will be blinking.

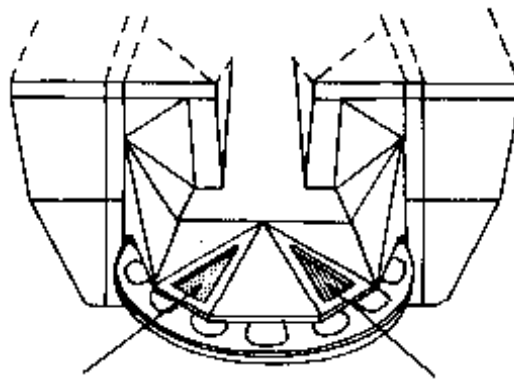

TOPO FOOTLIGHTS

These footlights indicate only the direction of wheel rotation and, along with the storage compartments, are found only on the Signature Edition TOPO.

Your TOPO is numbered and will be registered in your name, commemorating your leadership in the Age of Androbotics.

Section 1

INTRODUCTION

"Robots are not people. Mechanically they are more perfect than we are."
- Karel Čapek, R.U.R.

INTRODUCING TOPO

You have purchased a product that was pure science fiction a few short years ago - a personal robot. As you learn more about your new robot (we have named it TOPO, after topography or topology), you will come to realize that you are a pioneer in a totally new and exciting field. Whether your applications are practical, educational or just for entertainment, you will soon be making TOPO do things that no one has ever made it do before.

Regardless of your applications for TOPO, we know one thing - you will enjoy using TOPO. TOPO will soon become a family member as it cruises around the house, obeying your commands to navigate, talk or play games. Your enjoyment and appreciation will grow as each software or hardware accessory and utility package is added.

We know that you are anxious to get TOPO on its way, and that you do not want to read this entire manual first. In order to make this process as easy as possible, this manual is divided into sections guiding you from the most simple TOPO operations through the intermediate level to the most advanced uses. Detailed instructions are included for the

computer buff, or for anyone who wishes to explore TOPO's full potential.

TOPO can "walk" in any direction on a level surface, and can be made to "talk" in English and in various other languages.

TOPO's movements can be simple, from point-to-point, or complex and refined. You will learn to make TOPO perform ever more complex movements and to talk with an almost limitless vocabulary of words and phrases.

Once TOPO is unpacked and operational, a preprogrammed demonstration routine will make your robot perform a variety of basic activities to ensure that it is functioning properly. TOPO will introduce itself to you, its new master. Then, we strongly urge you to read this entire manual. Each section contains valuable information.

TOPO GENERAL DESCRIPTION

TOPO is a computer-controlled personal robot that can be programmed to "walk" over any path on a level surface.

TOPO can be directed to speak with its programmable voice. In addition to its basic speech, TOPO's voice can be finely tuned and shaped to sound more natural. TOPO can even be made to sing by controlling the pitch of its voice.

TOPO enjoys a drive system that provides stability and safety without compromising maneuverability and control. This patented drive system is called "Andromotion." It gives TOPO a unique personal gait and the ability to

remain upright at all times.

TopoSoft, a FORTH-based program developed by Androbot Inc., offers simple, easy programmability for TOPO.

Messages and commands are sent to TOPO through a remote-control, infrared transceiver called the "base communicator."

Complete electrical, mechanical and environmental specifications for TOPO and its base communicator are provided in the Appendix section of this manual.

WHAT DO I NEED TO USE TOPO?

Your TOPO robot needs a computer to send it instructions. The version you have purchased is designed to be used with an Apple II+ or IIe computer.

- To use TOPO, you should have an Apple II+ or IIe computer system with at least 48K of RAM.
- To use the enclosed TopoSoft diskette, you will need a disk drive (16 sector).
- The Apple computer must have a Super Serial Card (an RS-232C serial port) for connecting the base communicator.
- For manual control of TOPO, you must also have an analog joystick connected to your computer.

Figure 1 shows the interconnections and relationship of TOPO to the battery charger, base communicator, computer and joystick.

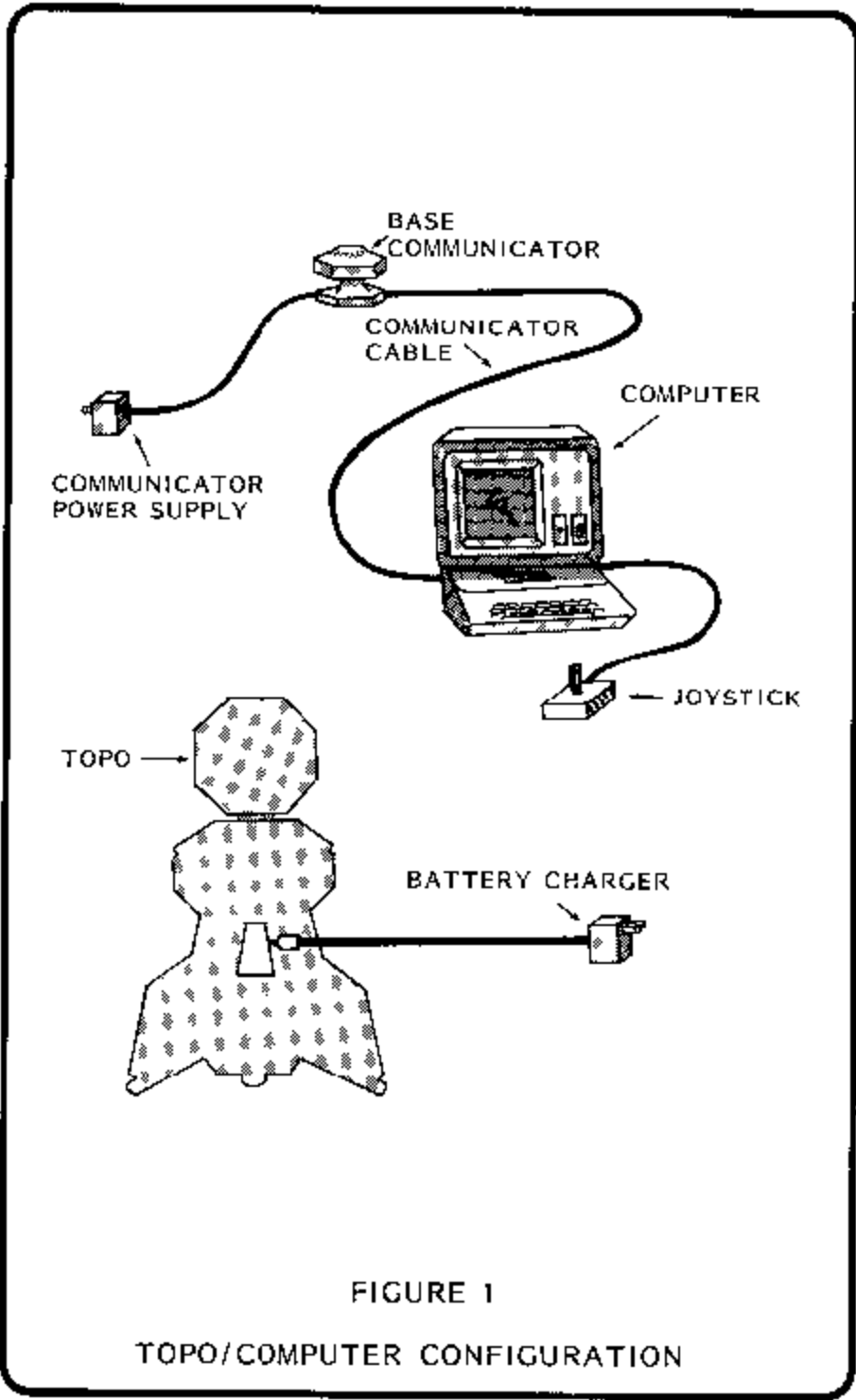

Figure 2 shows TOPO from front and back views.

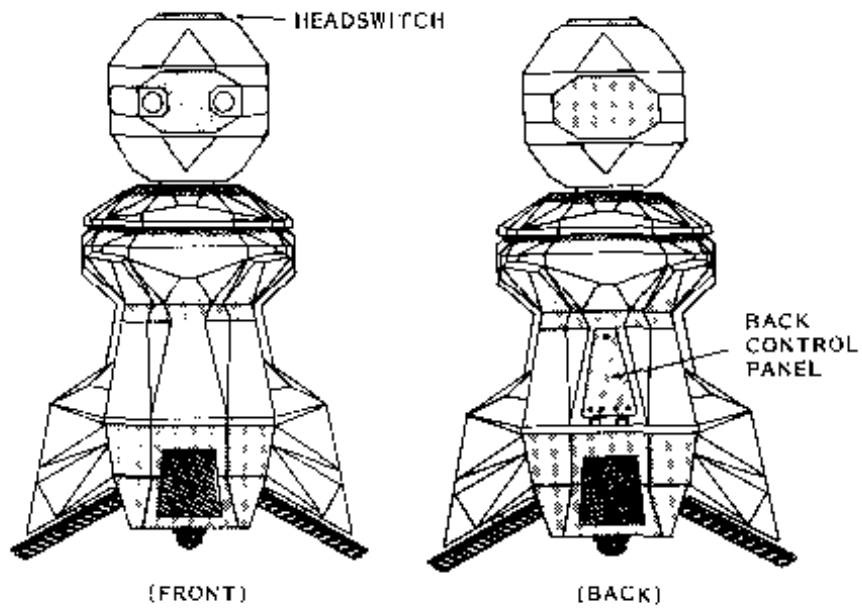

FIGURE 2

TOPO

The TOPO commands you will learn in this manual are based on the Mountain View Press (MVP) version of the FORTH computer language. As you learn the various movement and speech commands, you are really using the basics of FORTH.

Although even a newcomer to computers can quickly learn to control TOPO with the simple commands in this manual, even more interest and enjoyment will be yours if you acquire a more thorough knowledge of FORTH.

We recommend these books:

- **STARTING FORTH**
by LEO BRODIE
PRENTICE-HALL, INC.
\$18.00 (soft cover)
.....If you wish to buy only one book, this is the one - an excellent tutorial for programmers and non-programmers alike. Appendix F of this manual lists necessary corrections to STARTING FORTH.

- **ALL ABOUT FORTH**
by GLEN B. HAYDON
MOUNTAIN VIEW PRESS, INC.
\$25.00 (soft cover)
.....The recommended reference work for the FORTH programmer.

- **MVP-FORTH SOURCE LISTINGS**
by G. HAYDON and R. KUNTZE
MOUNTAIN VIEW PRESS, INC.
\$20.00 (soft cover)
.....Actual source code for MVP FORTH (written for the Apple II and IBM personal computers, and 8080-based CP/M systems).

These books should be available at your local bookstore or computer dealer, or write to

MOUNTAIN VIEW PRESS, INC.
P.O. BOX 4656
MTN. VIEW, CA 94040
(415) 961-4103

There is one last comment to be made before you unpack TOPO: TOPO IS NOT A TOY. TOPO is a full-fledged robot.

TOPO uses only industrial grade components throughout, from high quality rechargeable batteries and a professional infrared transceiver, to sturdy motors and cast aluminum gearboxes, a fabricated steel framework and a high-impact body. With proper care, TOPO will provide years of trouble-free service. And that matters to us, because providing service to humans is what robots are all about.

Section 2

INSTALLATION

"Help me to get moving, young lady, and I'll do anything you ask."

*- The Tin Woodsman to Dorothy
The Wizard of Oz*

©1939, Metro-Goldwyn-Mayer

UNPACKING TOPO

Your TOPO robot system comes packed in one box. As you unpack this box you will find:

this manual and owner registration cards,

a diskette containing the TopoSoft program (inserted in a plastic sleeve in the back of this manual),

TOPO's battery charger (the larger of the two black boxes with a built-in wall plug and power cord attached),

TOPO's base communicator (the hexagonal device with three red sides in the front),

the communicator power supply (the smaller black box with a built-in wall plug and power cord attached),

the communicator cable (with a 9-pin connector on one end and a 25-pin, RS-232C connector on the opposite end,

and one TOPO robot.

Packed in the foam insert are all the items listed above, except TOPO. Remove and set aside the base communicator, battery charger and cables, then remove the large foam insert. Underneath, you will find TOPO.

In lifting TOPO from the box, DO NOT LIFT TOPO BY THE HEAD. Reach down around both sides of TOPO at the shoulder area, as shown in Figure 3. Midway down TOPO's body are flat areas suitable for hooking your hands. Gently lift TOPO from the carton and gently set it on the floor in an upright position.

— CAUTION —

NEVER LIFT TOPO BY THE HEAD, AND NEVER DROP TOPO. EVEN THOUGH TOPO CAN TAKE A LOT OF ROUGH AND TUMBLE ACTION, THE ROBOT IS A SOPHISTICATED ELECTRONIC DEVICE THAT CAN BE DAMAGED IF DROPPED.

Once TOPO is out of the shipping carton, continue to lift it from underneath the shoulder area with both hands, as shown in Figure 3. TOPO can also be lifted from underneath its base.

If you look near the bottom of TOPO, you can see that it moves on two large wheels positioned at an angle to each other. This is the proper orientation for these wheels. TOPO balances in an upright position of its own accord, and if you give it a slight push, you will see that TOPO rocks back and forth a little bit without tipping over. This rocking motion is normal, and helps keep TOPO from damaging itself or anything it might run into by accident.

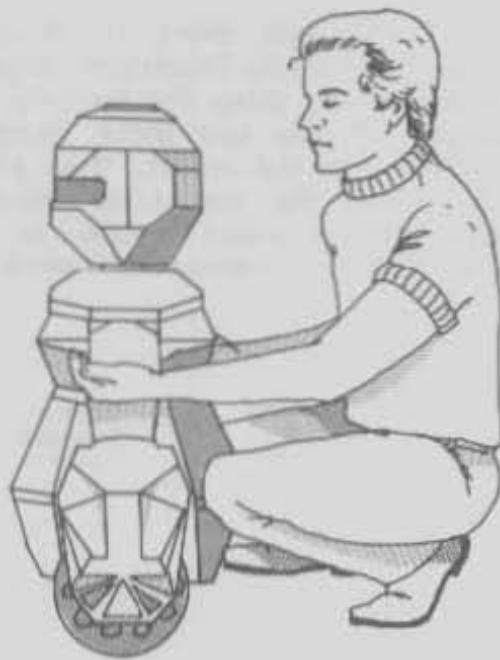

FIGURE 3

PROPER WAY TO LIFT TOPO

Now, check TOPO to be sure that it has not been damaged in transit. In the unlikely event that TOPO has been damaged, immediately contact your Androbot dealer for instructions.

TOPO's batteries may not be fully charged when you unpack the robot. For this reason, we recommend that you charge TOPO's batteries overnight before you turn the robot on for the first time.

CHARGING TOPO'S BATTERIES

Gently lift TOPO and move it close to a standard 115 V, 60 cycle electrical outlet. To charge the batteries, plug the battery charger (the larger of the two black boxes with attached cords) into the outlet, then plug the charger cord into the connector located on TOPO's back control panel, shown in Figure 4. Be sure TOPO is turned off while being charged.

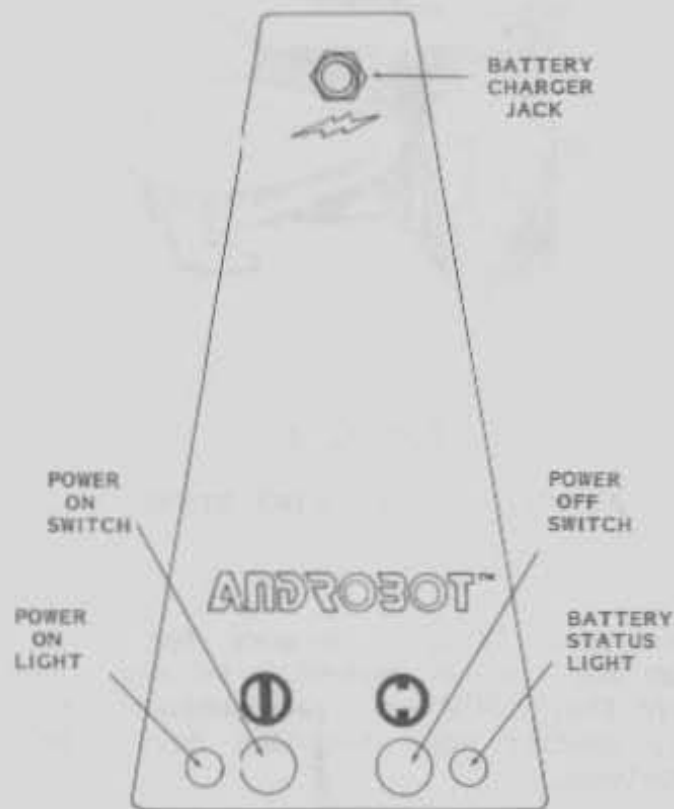

FIGURE 4

TOPO BACK CONTROL PANEL

The batteries can be completely recharged overnight. Once charged, they will provide hours of use before needing recharging. When TOPO is not being recharged, **BE SURE TO DISCONNECT THE BATTERY CHARGER FROM THE WALL OUTLET.**

To turn TOPO on, press the green power-on button located on TOPO's back control panel. When you press the power-on button, the power-on light and the battery status light will illuminate. If TOPO is operating, the battery status light should be green, indicating that the batteries are charged. When the battery status light is red, it is time to recharge TOPO.

TOPO has special battery protection circuitry. The overcharge protection circuit allows a full charge to be maintained by leaving the charger connected, with no possibility of damage. If you continue to operate TOPO after the battery status light turns red, the protection circuit will engage automatically and turn TOPO off. If this happens, simply charge TOPO overnight.

While TOPO's batteries are being charged overnight for the first time, you should fill out and mail the enclosed registration card. This will place your name and address on our list of owners so we can inform you of future engineering updates (in return, you will receive a free, one year subscription to the "Androbot Report" newsletter, featuring a regular exchange of information and new applications for TOPO, as well as articles of interest by experts in the field of robotics). We also suggest that you use this time to read the rest of this manual and to connect the base communicator to your computer.

MAKING TOPO MOVE MANUALLY

Even before you connect TOPO's base communicator to your computer, TOPO can perform basic movements by using the headswitch, shown in FIGURE 5.

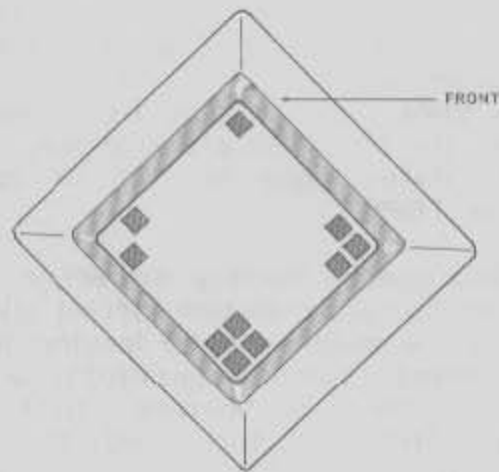

FIGURE 5

TOPO HEADSWITCH

CAUTION

YOU ARE ABOUT TO MAKE TOPO MOVE FOR THE FIRST TIME. BEFORE CONTINUING, CLEAR AN AREA AT LEAST FIVE FEET IN ALL DIRECTIONS AROUND TOPO.

After pressing the power-on button on TOPO's back control panel, you can make TOPO move forward, turn to the right and to

the left, and stop, simply by pressing the appropriate corner of the headswitch, as described below.

To make TOPO move forward, press the front corner of the headswitch, marked:



To make TOPO stop moving, press the back corner of the headswitch, marked:



To make TOPO turn to the right in place (while stopped), press the right corner of the headswitch, marked:



To make TOPO turn to the left in place (while stopped), press the left corner of the headswitch, marked:



You can also have TOPO make curving turns to the right or left by pressing either the right or left corner of the headswitch while TOPO is moving forward.

Practice making TOPO move by pressing the headswitch. This will give you a feel for TOPO's movement characteristics. In Sections 3 and 4 of this manual, you will learn how to use a joystick or type simple commands on your computer keyboard to make TOPO perform its full range of movements.

CONFIGURING THE SERIAL CARD

In order to connect the base communicator,

you should have an RS-232C Super Serial Card, installed in slot #2 of your Apple computer in accordance with directions supplied with the card (Appendix A provides instructions for configuration if you wish to use another slot for the serial card).

The switches on the card must be set to the proper configuration in order for the computer to communicate with the base communicator.

The switches should be set as follows:

<u>SWITCH 1</u>	<u>SWITCH 2</u>	<u>JUMPER</u>
0001111 * 1234567	1111000 * 1234567	Block triangle: pointing up (▲) toward "MODEM"

* 0 = OFF
1 = ON

This configuration is: Communications mode, 9600 baud, 8 data bits, 1 stop bit, no parity, no automatic linefeeds, no interrupts.

INSTALLING THE BASE COMMUNICATOR

The base communicator is the device that sends and receives instructions between TOPO and your computer. It is housed in a hexagonal plastic case with three red sides in the front and two jacks located on the back of the unit. The base communicator is shown in Figure 6.

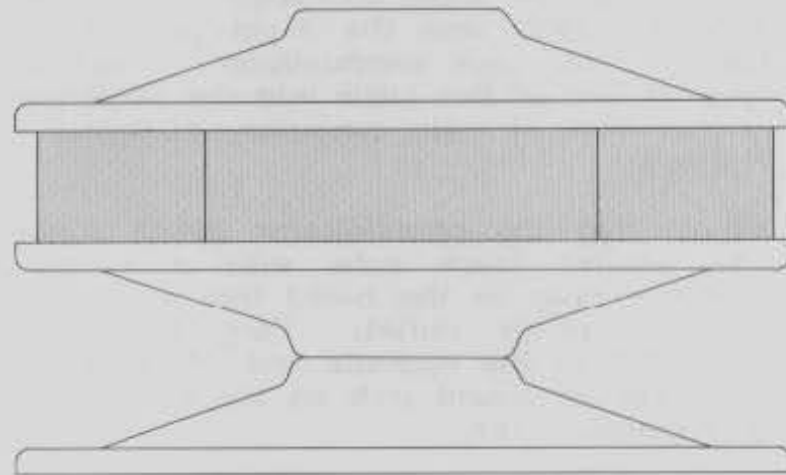

(FRONT)

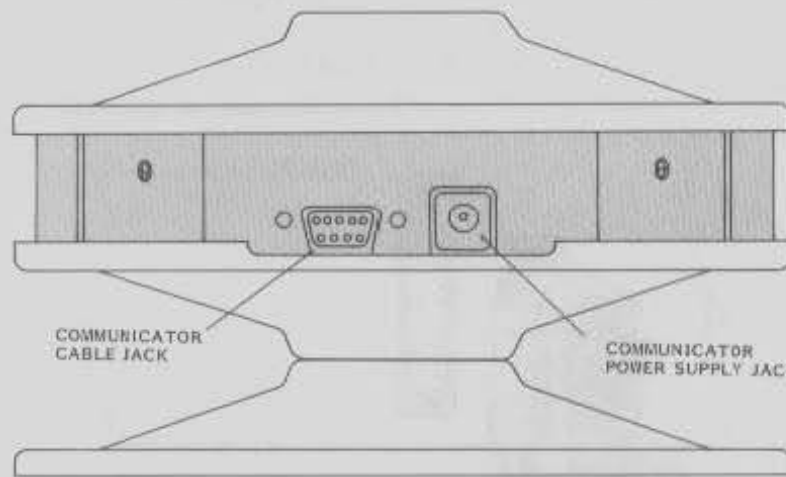

COMMUNICATOR
CABLE JACK

COMMUNICATOR
POWER SUPPLY JACK

(BACK)

FIGURE 6

BASE COMMUNICATOR

On the back of the base communicator, you will see a round jack for the communicator power cord and a 9-pin jack for the communicator cable (see detail in Figure 6).

First, plug the 9-pin connector on the communicator cable into the 9-pin jack on the back of the base communicator. Plug the opposite end of this cable into the serial port on the back of your computer, as shown in Figure 7.

Then, plug the communicator power supply (the smaller black cube with a standard electrical plug on the back) into a standard electrical power outlet. Plug the round connector on the opposite end of the power cord into the round jack on the back of the base communicator.

A red light will emit a steady glow from the center of the red front panel to indicate that the base communicator is operational.

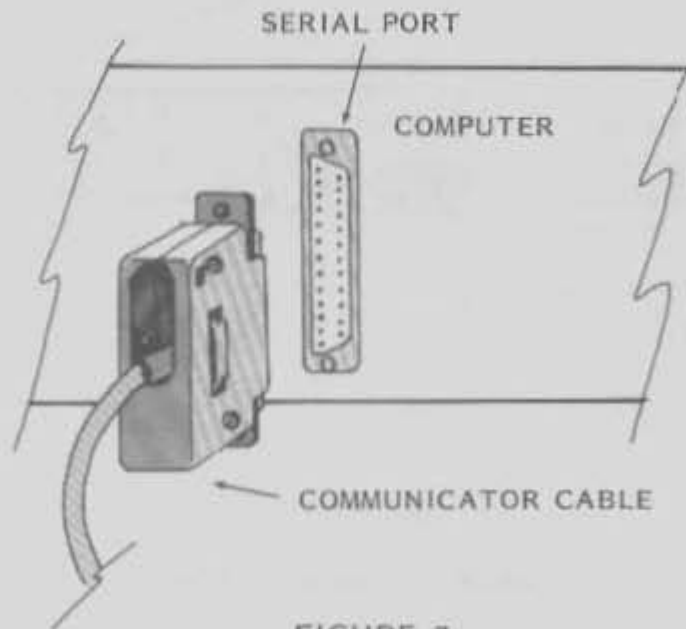

FIGURE 7

COMPUTER/BASE COMMUNICATOR
CABLE CONNECTION

LOCATING THE BASE COMMUNICATOR

You should place the base communicator at least three feet away from your computer or any other electrical device to avoid electrical interference. Place the base communicator at tabletop height or higher, WITH THE THREE RED SIDES FACING THE ROOM.

The signals emitted from the base communicator will bounce off walls and other surfaces and should reach TOPO even if there are obstructions in the room. But, to get maximum range from TOPO, be sure that the base communicator is placed in an unobstructed location, with the three red sides in a line-of-sight with TOPO. TOPO will stop whenever it moves out of range of the base communicator.

The base communicator will require no maintenance or attention on your part, other than placing it in a good location.

Now that you have connected the base communicator to your computer and have charged TOPO's batteries, you are ready to get TOPO moving and talking by remote control.

IMPORTANT

FOR COMPATABILITY WITH THE APPLE II+ COMPUTER, TOPOSOFTE USES ONLY UPPER-CASE CHARACTERS. IF YOU OWN AN APPLE IIe COMPUTER, BE SURE THAT YOUR CAPS LOCK KEY IS DEPRESSED WHEN USING THE TOPOSOFTE PROGRAM.

COPYING THE TOPOSOFT DISKETTE

All the computer instructions necessary to make TOPO obey your commands are contained on the TopoSoft diskette, packed in the clear plastic sleeve in the back of this manual.

The TopoSoft diskette includes instructions for your computer on how to follow your commands (these instructions are called, in programmers' terms, the "boot" image), and a copy of the source code used in writing those instructions.

The source code, which is discussed in Section 6, is included only as a reference for programmers.

Before going on, we strongly recommend that you make a copy of the boot image on a new, blank diskette. Use this copy whenever you operate TOPO, and save the original TopoSoft diskette in a safe place to avoid loss or damage.

To copy the boot image from the TopoSoft diskette, you must first "initialize" the blank diskette.

To do this, remove the TopoSoft diskette from its protective plastic sleeve and insert it in disk drive #1 (with the label facing upward and toward the front of the disk drive), and close the disk drive door.

Turn on your computer and wait several second for the system to load the information from your diskette. You will see the message

WELCOME TO TOPOSOFT V1.0 (C) ANDROBOT

You may also see an error message, such as

TOPO NOT RESPONDING

if your system is not completely set up, or if TOPO is not turned on. Even if this happens, you should still continue creating your new boot image diskette.

Remove the TopoSoft diskette and insert the blank diskette into disk drive #1. Then type the following command:

INIT-DISK

Press the RETURN key on the keyboard and the following message will appear on the monitor:

BLANK DISK IN DRV 1 (Y/N)?

When the message appears, type

Y

and the message

ERASING

will appear on the monitor, followed, in a few seconds, by the message

FORMATTING

After a few more seconds, the message

OK

will appear on the monitor, and the disk will be ready for copying.

To transfer the boot image onto the initialized diskette, type the command

SAVE-FORTH

Press the RETURN key, and

OPERATING SYSTEM DISK IN DRVL (Y/N)?

will appear on the display.

Type

Y

and the boot image will be copied onto the new diskette.

Once this is done, you should use the backup copy whenever you want to use TOPO.

POWER-ON ERROR CHECKING

When you first boot TopoSoft, it performs a complete check to ensure that the communication system is working properly. For this reason, you should turn on TOPO and plug in the base communicator before you boot TopoSoft.

If any error messages appear on the display, correct the problem and then press the RESET key on your computer. (On some Apple computers, the CONTROL key must be pressed and held down before pressing the RESET key. From this point on, we will just tell you to press the RESET key).

See the TROUBLESHOOTING chart in the APPENDIX section of this manual for a list of common error messages and how to resolve them.

After you RESET or boot the computer and no error messages appear, you are ready to use TOPO.

A MESSAGE FROM TOPO

Get ready, because the fun is about to begin.

Section 3 will explain the most basic commands you can give TOPO. Intermediate and advanced level commands are explained in later sections. But first, we would like you to get better acquainted with TOPO.

TOPO has a few things to show and tell. So, for a surprise, clear an area at least five feet in all directions around TOPO and type the following command on your computer keyboard:

DEMO

Then, press the RETURN key.

And we, too, would like to welcome you to the world of Androbotics, and to wish you well in your further adventures with TOPO.

Section 3

GETTING STARTED

1. *A robot may not injure a human being, or, through inaction, allow a human being to come to harm.*
2. *A robot must obey the orders given it by human beings except where such orders would conflict with the First Law.*
3. *A robot must protect its own existence as long as such protection does not conflict with the First or Second Law.*

*- The three immutable laws of robots
from "I, Robot"*

by Isaac Asimov

ABOUT THIS MANUAL

In this section, you will learn how to make TOPO obey the simplest movement and speech commands. Other sections provide instructions for intermediate level operations. For the programmer or more experienced owner, instructions are given for the most sophisticated kinds of activities.

Even the novice will soon be adept at making TOPO perform complex activities by using simple, logical commands.

For every command, an example is shown with the characters, symbols and spaces in the EXACT FORMAT you should follow when typing the commands on your computer keyboard.

One symbol used frequently in this manual tells you when to press the RETURN key on your computer keyboard. This symbol is:

- [R] This is the symbol we use for the RETURN key on your computer keyboard. Any command you give TOPO is activated only when you press the [R] key.

An example of a typical command sequence (these commands will direct TOPO to turn left 90 degrees and say "Hello") is shown below:

90 LEFT SAY" HELLO" [R]

— IMPORTANT —

TO MAKE TOPO OBEY ALL COMMANDS, BE SURE TO ENTER AT LEAST ONE SPACE WHEREVER SHOWN, AND DO NOT INSERT ANY SPACE IN THE MIDDLE OF A WORD. ALSO, REMEMBER TO TYPE ALL TOPO COMMANDS USING THE UPPER-CASE ALPHABET ON YOUR COMPUTER KEYBOARD, EXACTLY AS SHOWN IN OUR EXAMPLES.

If you ever misspell a command word, the monitor will underline the misspelled word and display the following error message:

NOT RECOGNIZED

Remember these simple rules and you will have no trouble making TOPO do your bidding.

JOYSTICK CONTROL

In a few moments, you will begin to learn how to make TOPO respond to commands entered on your computer keyboard. But TOPO can also respond to basic movement commands from an analog joystick.

Several widely available joysticks will work, so read the instructions provided with your joystick for directions on how to connect it to your computer.

To activate joystick control, type

JOYSTICK **[R]**

Now, you are ready to control TOPO with the joystick.

If TOPO moves slightly, even when the joystick is centered, adjust the trim levers on the joystick case (these levers are located on the top, bottom or side of the joystick case, depending on the brand and model) until TOPO stands absolutely still when the joystick is centered.

Orient the joystick in your hands so that pushing the joystick forward will make TOPO move forward. Then, move the joystick in several directions and practice guiding TOPO for a few minutes to get a feel for the speed of TOPO's responses.

To return control of TOPO to the computer keyboard, press either button on the joystick, or any key on the keyboard (the space bar or **[R]** key are recommended).

SIMPLE MOVEMENT COMMANDS

TOPO can be ordered to move forward and backward, and to turn right and left. Forward and backward movements are measured in centimeters (1 inch equals about 2.5 centimeters). Right and left turns are measured in degrees.

For example, to make TOPO move forward 200 centimeters (6 1/2 feet), just type the following command:

200 FWD [R]

To stop TOPO while it is moving, press the RESET key on your computer keyboard (we call this the "panic stop" RESET), or press the rear corner of TOPO's headswitch.

To make TOPO move backward 100 centimeters, type

100 BACK [R]

TOPO will make a 90 degree right turn with the command

90 RIGHT [R]

And TOPO will make a 135 degree left turn with the command

135 LEFT [R]

— IMPORTANT —

YOU CAN TYPE A MAXIMUM OF 80 CHARACTERS AT A TIME, SO BE SURE THAT YOUR COMMAND SEQUENCE IS NOT MORE THAN 79 CHARACTERS IN LENGTH - INCLUDING SPACES - BEFORE PRESSING THE **R** KEY. OTHERWISE, THE COMMAND WILL ACTIVATE AUTOMATICALLY WHEN YOU TYPE THE 80TH CHARACTER ON THAT LINE.

Later, you will learn how to make TOPO perform more sophisticated movements, and how to order TOPO to perform a number of activities in sequence, often requiring more than a single line of commands.

MAKING TOPO TALK

You can direct TOPO to speak in English and in various other languages with its text-to-speech voice feature. TOPO's voice can also be made to sound quite natural - even to sing - by controlling pitch, volume and speaking rate.

Section 5 of this manual provides detailed instructions for getting the most out of TOPO's speech module. The following paragraphs will get you started by explaining two of the most basic speech commands you can give TOPO.

To make TOPO talk, type the command "SAY" followed by a space, then type the

words you want TOPO to say, followed by a closing quotation mark. Be sure to put a space between every word. Press the **[R]** key and TOPO will start to talk.

For example, to make TOPO say "Hello. My name is TOPO," just type the following command:

SAY" HELLO. MY NAME IS TOPO" [R]

Try it, and then practice making TOPO say more words and phrases.

You will notice that TOPO's voice has some intonation, but still sounds somewhat mechanical. Section 5 will tell you the many ways you can refine and tailor TOPO's voice to sound more natural. One of these refinements can be achieved by changing the pitch of TOPO's voice.

TOPO's voice can be varied to sound lower-pitched or higher-pitched over a range of 63 steps, from 1 to 63. A setting of 1 is the lowest pitch, and a setting of 63 is the highest pitch (each increase or decrease of 20 steps will cause TOPO's voice to change by about one octave).

TOPO's pitch was set at the factory at 24 (this "normal" setting of 24 is called the "default value"), but you can change the pitch by using a simple SET-PITCH command. To change the pitch of TOPO's voice, type the number of the desired pitch (any number from 1 to 63) followed by a space and the command SET-PITCH. All SAY" phrases will now be spoken at the new pitch until you set the pitch again or turn off TOPO.

For example, to make TOPO say, "Hello. My name is TOPO" in a lower voice than you heard in the last example, type the command

5 SET-PITCH SAY" HELLO. MY NAME IS TOPO" [R]

Try it, and listen to TOPO's lower voice.

To make TOPO say the same sentence in a higher voice, type the same command with a high pitch number, as in this example:

50 SET-PITCH SAY" HELLO. MY NAME IS TOPO" [R]

To make TOPO's voice return to its original pitch, type the SET-PITCH command again, using a pitch value of 24, as shown below:

24 SET-PITCH [R]

Controlling pitch is only one of the ways you can make TOPO's voice sound different. Section 5 will show you how to explore the sophisticated features of TOPO's speech.

USER-DEFINED COMMANDS

TOPO can be programmed easily to perform a variety of activities in sequence using only a single, user-defined word or character. This feature of the TopoSoft program (and the FORTH programming language) is called creating a "colon definition."

For example, making TOPO perform a 90 degree right turn, say "Hello there," then turn left in a complete circle, will require the following string of individual commands:

90 RIGHT SAY" HELLO THERE" 360 LEFT [R]

You can make TOPO perform these same three activities with a single command. The name you choose for the command can be any character, symbol or combination of characters (except the space bar) - up to 31 characters in length.

For example, you may wish to name this routine "GREET" and have TOPO perform the sequence of activities whenever you type the command GREET. To do this, type the following commands, being sure to start the command line with a colon and end the command with a space and a semicolon before pressing **[R]**:

: GREET 90 RIGHT SAY" HELLO THERE" 360 LEFT ; [R]

Now, type the command

GREET [R]



This linking of activities under a single command (instead of using a chain of individual commands) is called creating a colon definition. The word GREET was used in this example, but remember, you can create a colon definition using any character, symbol or combination of characters up to 31 characters in length.

Some words may already be defined in TOPO's internal programs. Or, they may be distinct command words or words that have been used creating other colon definitions. For instance, if you had created the colon definition shown in the last example, but had used the word "LEFT" (a TopoSoft command word), instead of "GREET," the computer monitor would display the message

LEFT ISN'T UNIQUE

LINE 1 LINE 2

You could still use the new word "LEFT," but now you could no longer make TOPO do a simple left turn with the LEFT command. So be sure to use unique words for your colon definitions.

To erase the duplicate word "LEFT" before exchanging it for another word, type the following command:

FORGET LEFT [R]

Then, create your colon definition using a different word.

Now, create some colon definitions of your own and see how easy it is.

You can create a colon definition using more than one command line by typing [R] whenever it is convenient (but never in the middle of a word). You will keep adding to your colon definition until you type the terminating semicolon.

At this point, any colon definitions you create will be lost when you turn off the computer, or if you perform a "panic stop" RESET. In Section 4, you will learn how to save your colon definitions on the TopoSoft diskette.

You have now learned how to make TOPO perform basic movements and basic speech in response to commands from your computer keyboard. This is like teaching a child how to take his first steps and say his first words. In the following sections, you will learn how to expand TOPO's movement, speech and human interaction capabilities.

Section 4

MOVING ON

*"Dave, you know I am incapable of error."
- HAL 9000 Computer
2001, A Space Odyssey
©1968, Metro-Goldwyn-Mayer*

MORE ON MOVEMENT

In Section 3, you learned simple movement commands to produce basic forward and backward movement, and right and left turns. TOPO is also capable of refined movement, where you can control speed, acceleration and deceleration, perform smooth turns while TOPO is moving forward or backward, and make TOPO "park," while retaining any colon definitions you have created.

CONTROLLING TOPO'S SPEED

TOPO's initial speed was set at the factory, but you can make the robot move faster or slower by using the SET-SPEED command.

TOPO is set at the factory to move at a reasonable speed, but you can vary the speed from 1 centimeter/second to about 50 centimeters/second, depending on the charge level of the batteries. For example, to make TOPO move at a slower speed, type

10 SET-SPEED R

and all subsequent motion commands will make TOPO move at the new speed.

Try faster and slower speed movements using the SET-SPEED command.

ACCELERATION/DECELERATION RAMP

TOPO does not begin or end a movement at top speed, but with gradual acceleration to speed and gradual deceleration at the end of a movement. This acceleration/deceleration "ramp" is measured in centimeters per second per second (cm/sec^2). You can alter the ramp value over a range of 1 to 255.

To make TOPO reach top speed very quickly and slow down abruptly at the end of a move, type

250 SET-RAMP [R]

To make TOPO reach top speed and slow down at a very gradual rate, type

20 SET-RAMP [R]

or a similar command.

To reset TOPO's ramp speed to the original setting, type the command

RESET-MOTION [R]

The RESET-MOTION command will also stop TOPO, and will reset SET-SPEED and SET-RAMP values to their original default settings.

CURVED PATH MOVEMENT

In Section 3, you learned how to make TOPO perform right and left turns in place and straight-line motion. You can also make TOPO perform curved path motion with the command ARC.

ARC is made to work by telling TOPO the angle and distance of the curve, in degrees and centimeters.

The ARC command requires an entry for BOTH angle and distance. For example, the command

90 100 ARC [R]

will make TOPO perform a 90 degree right turn while moving forward over a distance of 100 centimeters.

To make TOPO curve to the left, type a - (minus) immediately before the degree entry. For example, the command

-90 100 ARC [R]

will make TOPO perform a 90 degree left turn while moving forward over a distance of 100 centimeters.

If you type - (minus) in front of the distance, TOPO will perform the curve while moving backward. For example, the command

180 -100 ARC [R]

will make TOPO perform a 180 degree right turn while moving backward over a distance of 100 centimeters.

The command

```
-90 -100 ARC [R]
```

will make TOPO perform a 90 degree left turn while moving backward over a distance of 100 centimeters.

Try the command

```
360 300 ARC [R]
```

and watch TOPO turn to the right in a complete circle.

Now, try the command

```
720 -600 ARC [R]
```

In this example, you saw TOPO make two full backward circles.

What happens if you specify an ARC command using "C" for one of the entries? For example, type these two commands and watch what happens:

```
0 100 ARC [R]
```

```
90 0 ARC [R]
```

As you may have expected, in the first example, TOPO interprets an ARC command with 0 degrees as a simple FWD command, because the command told TOPO to move forward 100 centimeters while turning 0

degrees. In the second example, TOPO interprets the ARC command with 0 distance the same as a simple 90 RIGHT command.

In fact, the simple movement commands you learned in Section 3 (FWD, BACK, LEFT and RIGHT) are really all ARC commands in disguise.

Now you are ready to practice the ARC command by making up some of your own. And, while you are at it, try linking some simple movement commands with ARC commands, and create some colon definitions linking all the commands you have learned.

INTERRUPTING A MOVEMENT COMMAND

While performing a sequence of movement commands, you may wish to interrupt TOPO and go on to another operation. As you learned earlier, the RESET-MOTION command will make TOPO stop moving, but it will also reset the SET-SPEED and SET-RAMP parameters back to their default values. The "panic stop" RESET will work, but it also discards any colon definitions you may have created.

To stop TOPO in the middle of a movement and retain all the parameters, type the command

PARK R

The PARK command will make TOPO stop immediately, and discard any remaining movement commands you have typed (while

retaining your SET-SPEED and SET-RAMP values).

INTRODUCING A DELAY WHILE MOVING

You can direct TOPO to delay starting a new activity (such as speech) until it has finished performing movement commands.

For example, you may wish to have TOPO move forward, turn around and THEN begin talking. If you typed the appropriate commands in sequence, TOPO would begin talking almost immediately after beginning its forward movement.

To delay the speech until TOPO has finished ALL movement commands, type the command TILL-STOPPED before the speech command, as in the following example:

```
100 FWD 180 RIGHT TILL-STOPPED SAY" HELLO" [R]
```

HEADSWITCH USES AND COMMANDS

When you first turn on TOPO, pressing the headswitch will make TOPO move forward, perform right and left turns, and stop, as discussed in Section 2. In this state, the headswitch is in the HEADFOLLOW mode.

If you are controlling TOPO from your computer keyboard and wish to disable the HEADFOLLOW function, type the command

```
DISABLE-HEADFOLLOW [R]
```

Now, TOPO will stop automatically whenever you press any headswitch. To return TOPO to the HEADFOLLOW mode, type this command

ENABLE-HEADFOLLOW [R]

In Section 6, you will learn how to read the headswitch values in order to control a great variety of movement and/or speech activities.

PRECISION POSITION CONTROL

In normal configuration, TOPO will attempt to blend one movement command with the next. This blending mode is called MOVE-SMOOTH and is the default setting for TOPO. The MOVE-SMOOTH mode, while reasonably accurate, may introduce small positioning errors that could accumulate over time.

To assure more precise positional control, use the MOVE-EXACT mode, by typing the command

MOVE-EXACT [R]

The MOVE-EXACT mode will cause TOPO to come to a brief, full stop between all further movement commands, ensuring even more precise movement.

Use the MOVE-SMOOTH command to return to smooth motion. (RESET-MOTION will also set motion to smooth).

RESETTING MOVEMENT/SPEECH PARAMETERS

An additional reset command will stop TOPO and reset all on-board parameters (SPEED, PITCH, HEADFOLLOW etc.) to their default values. To activate this command, type

RESET-TOPO R

This command will cause TOPO to perform a complete power-on cycle.

SAVING COLON DEFINITIONS

When you turn off your computer, or if you do a "panic stop" RESET, all the colon definitions you have created will be lost, and must be recreated if you wish to use them again.

These colon definitions can be saved on your diskette if, before turning off your computer, you type the following command:

SAVE-FORTH R

To execute the SAVE-FORTH command, you should have the boot disk in disk drive #1.

Section 5

SPEECH

"If you do not speak English, I am at your disposal with 137 other languages, along with their related dialects & subtongues."

*- Robbie the Robot
Forbidden Planet
©1956, Loew's Incorporated*

ABOUT THIS SECTION

TOPO has a sophisticated system called "text-to-speech" which allows you to instruct TOPO to say exactly what is typed on the computer keyboard. The "text" you type is converted into strings of phonetic characters by rules stored in TOPO's speech module. Other rules change these symbols into speech sounds that are also stored in the speech module.

This section explains all the commands you can use to tell TOPO what to say and what kind of voice to use while talking. You will also learn how to make TOPO perform some advanced voice functions.

To introduce you to the many ways you can control TOPO's speech, here is a list of the commands we will discuss in this section, with a brief definition of each one:

SAY"	Speak (the following words), as if reading.
------	---------------------------------------------

SET-PITCH	Set the overall pitch level of TOPO's voice.
SET-VOLUME	Set the overall volume level of TOPO's voice.
TALK-FAST	Speak faster than the normal rate.
TALK-SLOW	Speak at a normal rate.
TALK-LEVEL	Speak in a monotone.
TALK-WAVY	Speak with normal, variable intonation.
TILL-SILENT	Process no other commands until TOPO is finished talking.
SAY#	Speak the answer to an arithmetic problem.
SAY-LATER"	Do not speak (the following words) until ordered to speak.
SAY-IT	Speak all SAY-LATER" phrases.
SAY-WORDS	Put word boundaries at every space or punctuation, as in normal speech. No effect in phonetic mode.
SAY-LETTERS	Pronounce each letter individually. No effect in phonetic mode.

SAY-SOME-PUNC	Do not pronounce ordinary punctuation. No effect in phonetic mode.
SAY-MOST-PUNC	Pronounce ordinary punctuation. No effect in phonetic mode.
SAY-ALL-PUNC	Pronounce all punctuation, spaces, etc. No effect in phonetic mode.
RESET-SPEECH	Reset the speech module to power-on state and cancel any currently executing speech.
PHON"	Speak the following phonetic symbols.

As we discuss each command, you will see an example of how that command is used. These examples are shown in the EXACT FORMAT you should follow when typing the command on your computer keyboard. Remember to type all characters (including punctuation and spaces) exactly as shown.

Two new symbols are used in this section. One of the symbols is used to represent a string of words or characters, and the other is used to represent a numerical value.

For example, the SAY" command is always followed by a string of characters, represented in this section by the symbol string. The string shown after the SAY" command, below, represents the character or words you want TOPO to speak.

SAY" string" [R]

As in previous examples, the **[R]** is the RETURN key on the computer keyboard.

In some other commands, you will have to specify a numerical value, such as for a pitch level. These numbers, which must be typed in front of the actual commands, are symbolized by n, as shown below:

n SET-PITCH [R]

All commands that include a quotation mark (SAY", PHON" and SAY-LATER") must also have a closing quotation mark after the string of characters you want TOPO to speak, as in this example:

SAY" string" [R]

Remember that there must be a space after the command SAY" but it does not matter whether there is a space before the closing quotation mark.

TEXT-TO-SPEECH MODE

TOPO will speak any words you type after the SAY" command. For example, to make TOPO say "Hello. My name is TOPO" type the following command:

SAY" HELLO. MY NAME IS TOPO" [R]

TOPO begins to talk when you press **[R]** at the end of the line.

Punctuation marks have an effect on TOPO's speech. With any text you type using the SAY" command, the speech module knows that

it should make TOPO's voice pitch go down before a period (or colon or exclamation point), and stay level before a semicolon or a question mark.

The speech module will also insert pauses after commas - more commas produce longer pauses.

How much can you get TOPO to say at one time? Each SAY" command can be followed by as many words as can be written on an 80-character line. Or you can write as many lines of text as you like if you create a colon definition, discussed in Section 3.

There is normally no limit on sentence length: TOPO can speak a single syllable, or a sentence dozens of words long. However, TOPO can accept no more than about 1700 characters at a time without getting into trouble. After that, some characters may get lost.

CONTROLLING TOPO'S PITCH AND VOLUME

You can affect the pitch and the loudness (volume) of everything TOPO says by using SET-PITCH and SET-VOLUME commands. Both of these commands require an n value at the beginning of the command.

The SET-PITCH command changes the overall pitch of TOPO's speech, on a scale of n = 1 to 63. The highest pitch is 63, the lowest is 1, and the preset, or "default" value (TOPO's pitch when you turn on the power), is 24. Each increase or decrease of 20 steps will cause TOPO's voice to change by about one

octave. For example, the command

1 SET-PITCH [R]

sets the pitch to about an octave lower than the command

21 SET-PITCH [R]

You can make TOPO speak in a softer or louder voice by using the SET-VOLUME command. TOPO's default volume is 12, on a scale of $n = 0$ to 15.

For example, to make TOPO speak in a very quiet voice, type

5 SET-VOLUME [R]

To return to the original volume, type

12 SET-VOLUME [R]

Every time TOPO is turned on, the preset default values are present.

CONTROLLING TOPO'S SPEECH RATE

TOPO's rate of speaking is preset at the factory to sound like natural, relaxed human speech. You can make TOPO talk at a faster rate by using the command TALK-FAST. For example, to make TOPO say "How are you today?" at a faster rate than normal, type the following commands:

TALK-FAST SAY "HOW ARE YOU TODAY?" [R]

To return TOPO's speech to the normal rate,

use the command TALK-SLOW as in this example:

TALK-SLOW SAY" HOW ARE YOU TODAY?" [R]

Only these two speech rates are defined by commands. To make TOPO talk more slowly than normal, insert commas (pauses) between words and sentences, or try lengthening vowels, as discussed later in the subsection on special effects.

CONTROLLING TOPO'S INTONATION

Some intonation (pitch contour) is programmed into TOPO's voice at the factory. This intonation is assigned to each sentence by a set of rules in TOPO's hardware.

These rules are based on an examination of typical speech patterns used in English, and cannot be modified by the user. They will cause foreign languages (discussed later in this section) to sound as though they are being spoken with a decidedly American accent.

The intonation of TOPO's speech can, however, be turned off with the TALK-LEVEL command. For example, to remove all intonation so that TOPO speaks in a monotone, type the following command:

TALK-LEVEL SAY" SNOW FALLS IN WINTER" [R]

To return to the automatic intonation assignment, use the command TALK-WAVY as in the following example:

TALK-WAVY SAY" SNOW FALLS IN WINTER" [R]

DELAYING COMMANDS DURING SPEECH

Normally, TOPO will respond to consecutive speech commands and movement commands almost simultaneously. For instance, a lengthy speech string followed by a movement command will cause TOPO to begin moving while still speaking. You can make TOPO delay the movement command until finished with the speech by using the TILL-SILENT command, which orders TOPO to delay all further activities until finished talking.

For example, with the command

SAY# HELLO THERE# 360 RIGHT [R]

TOPO will begin turning while still talking.

But, with the command

SAY# HELLO THERE# TILL-SILENT 360 RIGHT [R]

TOPO will finish talking before beginning the turn.

PRONOUNCING NUMBERS

TOPO can speak the answers to arithmetic problems solved by your computer if you use the SAY# command. For example, listen to what happens when you type this command:

5 SAY# [R]

In fact, TOPO will speak any number resulting from any operation if you use the SAY# command.

To hear the answer to the problem "10 minus 3," try this command

10 3 - SAY# R

(The above example of an arithmetic entry is correct. See **STARTING FORTH** for an explanation of mathematics in **FORTH**.)

ACTIVATING STORED SPEECH COMMANDS

You may want to write a string of words or sentences that **TOPO** will remember, but not speak until you give the command. This is especially useful if you have several **SAY** commands in a row and do not want **TOPO** to do anything until you have finished typing all of them. This situation calls for a **SAY-LATER** command.

The character string following a **SAY-LATER** command is sent to **TOPO** as soon as you finish typing the line, but **TOPO** is told not to speak at that point. A second **SAY-LATER** following the first sends a second line that queues up behind the first line, and will be spoken right after it as soon as you give the command to talk.

To make **TOPO** speak the messages stored in all previously unspoken **SAY-LATER** commands, type the following command:

SAY-IT R

Note that any other speech command, except **TILL-SILENT**, **TALKING**, **SPEECH-FULL?**, **RESET-SPEECH**, or another **SAY-LATER** will also activate the stored speech. For

instance, if you do a SAY-LATER" and then a SET-PITCH, the stored speech will be activated.

PRONOUNCING WORDS AND LETTERS

TOPO's normal speech behavior is to speak words the way we normally do. This standard method of speaking corresponds to the command

SAY-WORDS [R]

But, in addition to speaking words, TOPO can spell them out if you type the command

SAY-LETTERS [R]

PRONOUNCING SYMBOLS AND PUNCTUATION

TOPO will normally pronounce by name only the following special symbols:

@ # \$ % & * + = < > /

This means that the symbols

. . : : ' ? ! () []

may be used as punctuation marks when you are typing sentences for TOPO to say, just as they are used in normal human speech. However, . (period) is pronounced when it is followed immediately by another character and not by a space.

For example, type the following command and listen to the result:

SAY" 3.4Z" [R]

TOPO will only pronounce large numbers digit-by-digit. You will have to write out phrases like "one hundred sixteen dollars and thirty five cents" if you want them to sound right, rather than typing \$116.35.

TOPO's normal attitude toward punctuation corresponds to:

SAY-SOME-PUNC [R]

which is the default setting.

In the SAY-SOME-PUNC setting, some of the punctuation will be spelled out, but not the symbols we most commonly use as punctuation.

The symbols listed above that are NOT pronounced in the SAY-SOME-PUNC setting (for example, commas) will be pronounced if you type

SAY-MOST-PUNC [R]

The command

SAY-ALL-PUNC [R]

makes TOPO comment on the occurrence of spaces, linefeeds and carriage returns as well - things you do not notice, but which occur naturally as you type on your computer keyboard.

RESETTING SPEECH FUNCTIONS

The RESET-SPEECH command will reset TOPO's speech module by returning it to the default state it is in at power-on. This command will silence TOPO immediately, and all speech parameters that you may have altered (SET-PITCH, SET-VOLUME, etc.) will be reset to their default values.

BETTER SPEECH WITH SAY"

TOPO's speech module is very good at saying whatever you type, but it is not perfect. To improve TOPO's pronunciation in text-to-speech mode, you can use your knowledge of written English to play tricks on the speech module. For example, the name CHRIS will be pronounced as if it had a 'z' on the end. If you spell it CHRISS (as in MISS), the 's' will come through clearly.

Table 5-1 is a collection of alternative spellings for various sounds. Some of the examples indicate changes that must be made from the original spelling, and some do not. (Most of the time, of course, TOPO will pronounce words correctly without your intervention.)

The sound is represented by the underlined portion of a word containing it. The general rule of thumb is: think of another word that has the same sound, but in which the sound is spelled differently, and try using that type of spelling. You do not have to change the spelling of an entire word - just the spelling of the part that is causing problems. Also, sometimes when there is a problem, you do

not have to change the spelling at all. Just put a space between syllables, as in the final set of examples in the table.

TABLE 5-1
SPELLINGS FOR BETTER PRONUNCIATION

<u>SOUND</u>	<u>ALTERNATIVE SPELLING(S)</u>	<u>EXAMPLES</u>	
<u>bee</u>	EE ach <u>ie</u> ve	<u>ce</u> ase	CEESS
<u>it</u>	I IH	<u>pre</u> tt <u>y</u> <u>w</u> om <u>e</u> n	PRITTY WIHMIN
<u>ate</u>	AY, AI A <u>_</u> E	<u>a</u> ch <u>e</u> <u>ph</u> as <u>e</u>	AYK FAZE
<u>bet</u>	E EH	<u>bre</u> ath <u>ne</u> ph <u>ew</u>	BRETH NEH FEW
<u>bat</u>	AE	<u>na</u> tional	NAE TIONAL
<u>but</u>	U UH A	<u>no</u> ne <u>a</u> b <u>ov</u> e <u>a</u> qu <u>a</u>	NUN UHBUV OKWA
<u>ah</u>	o	<u>fa</u> ther	FOTHER
<u>too</u>	oo EW	<u>lo</u> se <u>bru</u> ise <u>ave</u> nu <u>e</u>	LOOSE BROOZE AVIH NEW
<u>toe</u>	O OW OE O <u>_</u> E	<u>bo</u> ulder <u>co</u> lon <u>wi</u> ndow <u>sc</u> roll	BOLDER COWLON WIN DOE SCROLE

<u>ought</u>	O AW	<u>swan</u>	SWON
		<u>cost</u>	CAWST
<u>time</u>	Y EY ICH I E Y_E	<u>final</u>	FYNAL
		<u>ill</u>	EYELL
		<u>cycle</u>	SIGHCLE
		<u>height</u>	HITE
		<u>blind</u>	BLYNED
<u>how</u>	OU	<u>brown</u>	BROUN
<u>you</u>	U	<u>beauty</u>	BUTEE
<u>hair</u>	AIR ARE or AIR	<u>swear</u>	SWAIR
		<u>character</u>	CARE ECTER
<u>her</u>	ER or UR	<u>search</u>	SURCH
<u>hour*</u>	OUER	<u>devour</u>	DEVOUER
<u>label</u>	LE	<u>label</u>	LAYBLE
<u>quite</u>	KW	<u>aqua</u>	OKWA
<u>chip</u>	CH	<u>question</u>	KWESCHUN
<u>fix</u>	F	<u>alpha</u>	AL FA
<u>six</u>	SS	<u>gas</u>	GASS
<u>ship</u>	SH	<u>mustache</u>	MUSTASH
<u>fizz</u>	ZS	<u>his</u>	HIZS
	(space)	<u>advice</u>	AD VICE
		<u>alive</u>	UH LIVE
		<u>arrive</u>	UH RIVE
		<u>create</u>	CRE ATE
		<u>define</u>	DE FINE
		<u>depart</u>	DE PART
		<u>finish</u>	FIN ISH
		<u>goodbye</u>	GOOD BYE

TABLE 5-1 (continued)

maybe	MAY BE
micro	MY CRO
multiply	MULTI PLY
precise	PRE CISE
psychiatrist	SY KY UHTRIST
replacement	RE PLACE MENT
sideways	SIDE WAYS
taken	TAKE N
volume	VOL YOOM

* pronounced as two syllables

PHONETIC SPEECH MODE

In addition to its text-to-speech capability, TOPO has a second, quite versatile phonetic speech mode. In this mode, you can specify the actual sounds to be strung together to create more precisely the words (in any language) TOPO will speak.

Rather than typing the speech in standard spelling, you can use the phonetic (PHON") command with strings of special phonetic codes. The speech module that is TOPO's "voice box" handles either phonetic or ordinary character strings in response to the two different commands: PHON" or SAY".

For example, here is a command we saw in the discussion of SAY", but using the PHON" command

PHON" HE LO MI NEM EZ TO PO" [R]

The special phonetic codes, which represent actual sounds more closely than standard spelling, are shown in Table 5-2. But, before delving into them, you may wonder why we would want to use this method at all, since in the above example, the result doesn't sound any better than the SAY" example. Why go to the trouble?

One obvious answer is that this phonetic mode gives you a way of specifying the pitch and loudness of individual sounds and words quite precisely, which you cannot do with SAY" or any of the other commands presented so far.

Not only can you get the PHON" example to sound like the SAY" example, with normal spelling, you can get it to sound much better.

For an interesting demonstration, type the following commands:

```
PHON" HE3 L 30,3 M 71 NEM IZ TO3 P 30" R
```

```
PHON" H 7E L 20,3 M 71 N 4EM 6IZS T 90 P 20" R
```

```
PHON" —H7EL 20,3 M 41 NEM ++9<I3 =ZS ,2 —T 20 P 20"
```

In the first example, you reproduced the intonation that is automatically assigned when you use SAY". In the second example, the intonation is improved, so that the two sentences sound more natural. In the third example, a further change alters the meaning of the sentence.

You will have noticed that sentences in the PHON" mode should not be typed with any punctuation in the usual sense. The characters that we would normally use as punc-

tuation marks now stand for different speech sounds. You must specify all pitch changes and pauses yourself, using numbers to indicate pitch levels and commas to show pauses. We will provide more details below.

The period is used in a special way in phonetic mode. Try typing the following:

PHON" LAST HOP." R

The speech module has a special characteristic that will make TOPO speak the same sentence twice when it is followed by a period in phonetic mode: once with the pronunciation you expect from the phonetic codes that follow the PHON" command, and the second time as if this were a SAY" command. Thus HOP is pronounced two different ways in the PHON" example, above. You can confirm what is happening by typing

SAY" LAST HOPE. LAST HOP." R

Except for the pitch, this will sound the same as the previous example with PHON".

This feature can be useful for experimenting with TOPO's speech rules, but normally you will want to avoid its complications by remembering not to put a period at the end of a PHON" sentence.

In Table 5-2, the speech sounds are divided into vowels and consonants. (The reason for dividing the consonants into two classes will become clear later.)

The sound that each special symbol represents is explained by an example, the underlined portion of a short word. Most of the symbols have the same value in both this

phonetic mode and in regular spelling. But, as we saw above with HOP vowels may have different values for a given word.

English spelling is notorious for having the same letters stand for different sounds (as in though, though, cough and rough), and for having one sound represented by different letters (as in car, cop). The phonetic symbols eliminate both kinds of ambiguity, because a single symbol stands for a single sound - all the time. This is a second reason for using these symbols instead of common spelling: for some unusual words, it may be the easiest way to specify just how you want the word pronounced.

TABLE 5-2
PHONETIC SYMBOLS FOR SPEECH MODULE

<u>VOWELS, DIPHTHONGS</u>	<u>CONSONANTS (Class 1)</u>
& <u>bee</u>	P <u>pet</u>
l <u>it</u>	T <u>tie</u>
@ <u>ate</u>	K <u>kick</u>
E <u>bet</u>	B <u>bat</u>
A <u>bat</u>	D <u>dog</u>
U <u>but</u>	G <u>get</u>
' <u>about</u>	C <u>check</u>

TABLE 5-2 (continued)

:	<u>ah</u>	J	<u>job</u>
:	<u>too</u>	F	<u>fit</u>
Q	<u>took</u>)	<u>think</u>
O	<u>toe</u>	S	<u>see</u>
*	<u>ought</u>	\$	<u>she</u>
!	<u>time</u>	H	<u>hit</u>
?	<u>toil</u>	X	<u>azure</u>
#	<u>how</u>	<u>CONSONANTS (Class 2)</u>	
&	<u>you</u>	V	<u>very</u>
&R	<u>hear</u>	(<u>this</u>
@R	<u>hair</u>	Z	<u>zero</u>
'R	<u>her</u>	M	<u>man</u>
:R	<u>car</u>	N	<u>no</u>
QR	<u>tour</u>	/	<u>sing</u>
OR	<u>four</u>	L	<u>let</u>
!R	<u>fire*</u>	R	<u>red</u>
#R	<u>our*</u>	Y	<u>yes</u>
		W	<u>wet</u>

* pronounced as one syllable

FINE TUNING IN PHONETIC MODE

There are several ways to change a sound's pitch, length, or loudness, as we saw in the previous examples.

In phonetic mode, pitch can be set over a range of 9 steps, from 1 (the lowest pitch) to 9 (the highest pitch). The default value is 5, which is equivalent to the pitch you would hear with TALK-LEVEL.

The pitch values 1-9 used with the phonetic speech mode cover a range of about half an octave, with the base pitch 5 in the middle.

To change the pitch of a vowel or Class 2 consonant in phonetic speech mode, put a number from 1 to 9 to the immediate left of the phonetic symbol. It is also a good idea to precede the pitch value with a space, as in this example:

PHON* HE L 90" R

Any spaces in phonetic speech mode have no effect on pronunciation, but the space before the pitch value resolves any ambiguity as to the meaning of the value, as will become clear shortly.

Remember that TALK-LEVEL will disable any pitch variation, so you may need to give a TALK-WAVY command. TALK-FAST and TALK-SLOW will also have the expected effect, as will SET-PITCH and SET-VOLUME.

Try these examples:

PHONⁿ H 9E L0ⁿ [R]

PHONⁿ H 5E L 10ⁿ [R]

PHONⁿ H 4E L 90ⁿ [R]

PHONⁿ H 1E 5L 10ⁿ [R]

You can also change the pitch contour of a word by inserting one of the following symbols (listed with their meanings) in front of a sound.

> rising

< falling

= flat

The contour symbol must be typed to the IMMEDIATE left of the phonetic symbol. For example,

PHONⁿ H<REEEE>LLLLLOⁿ [R]

represents a vowel sound falling in pitch, two steps at a time, then a rise in pitch during a long L.

The pitch after one of these symbols will continue to rise, fall, or remain flat until either another pitch value (number or pitch contour symbol) or a Class 1 consonant (see Table 5-2) is encountered.

Try these examples:

PHON" H<EEEE>LLLLLO" R

PHON" H<EEFFFTY" R

PHON" H<EE 9LLO" R

You can also change the stress on vowels, but not on consonants. Stress values affect the length and pitch of a vowel. A strongly stressed syllable should have a 3 after it. We heard what this does in the MY NAME IS TOPO example earlier, in which the syllable IS was emphasized:

PHON" H 41 NEM 9<I3 -ZS,2 T 20 P 20" R

The value 2 means normal stress, and 1 after a vowel causes it to be REDUCED (to be much shorter, lower-pitched, and less distinctive in quality). You can get an even greater degree of reduction with a stress value of 0.

A number between 0 and 3 right after a vowel is always taken to correspond to a stress setting.

If the number is greater than 3, it is set equal to 3.

It is recommended that you always put a space after a stress value, as in

PHON" HE3 LO1 ,5 HEI LO3" R

This will eliminate any possible confusion between pitch values and stress values.

You can gradually change the loudness of TOPO's speech in PHON" mode by using the

symbol + to increase volume, and - to decrease it. These symbols can occur anywhere and there can be more than one of them in a row. Try this example:

PHON" EKO---EKO---EKO+++EKO+++EKO" R

We decrease the loudness of the second and third words three steps each (on the scale of 0-15), then bring it up again. This shows, as you would expect, that + and - cancel each other out, and you have to use one of them to counteract the effect of the other to return to the original volume.

As with pitch, this command makes an adjustment based on the latest SET-VOLUME value.

The final notation that is particular to phonetic mode is that used to insert a pause, or silence.

With SAY", a pause of a particular length is inserted at a comma. The comma is also used in phonetic mode to indicate a pause, one to nine units long. (The "punctuation" comma of SAY" is equivalent to about five of these units).

Each comma normally has a digit from 1 to 9 after it, as in this example:

PHON" H!,1 H!,4 H!,9 H!" R

Again, it is a good idea to follow each ,n with a space, to avoid ambiguity.

Any comma in phonetic mode without a following digit is interpreted as ,2 (not ,1). Thus, a sequence of three commas in a row is equivalent to ,6.

SPECIAL EFFECTS

The commands presented at the beginning of this section will allow the user to change some of the basic characteristics of the way TOPO talks. For example, you can make TOPO talk in a high, fast voice (like a cartoon character) using SET-PITCH and TALK-FAST.

To produce speech that is slower than normal, try inserting several more pauses. Some places in sentences respond to pauses better than others: anywhere you would put a punctuation mark; between subjects and verbs, or verbs and direct objects; before many instances of 'which' or 'that'; and so on. These are the places to try first - they may sound awkward in some sentences, fine in others. Experiment with a few sentences of your own.

TOPO is also quite adept at reciting rhymes and poetry, and even singing (you can put the appropriate pitch on each vowel using SET-PITCH commands), but then the speech must be tailored to particular rhythms. Changes in rhythm require not only carefully timed pauses, but alteration of vowel length.

Table 5-3 shows how to lengthen most of the vowels TOPO's speech module can produce. Those vowels not listed in the table do not sound very good when repeated to lengthen them. To lengthen a vowel even more, repeat the first character in the 'long vowel' column. To shorten a vowel, put a '1' after it, which indicates stress reduction. If you want to keep the pitch unchanged, put an appropriate pitch value in front of the vowel, too.

TABLE 5-3

HOW TO LENGTHEN VOWELS IN PHONETIC MODE

<u>SHORT VOWEL</u>	<u>LONG VOWEL</u>
G	GG
I	II
E	EE
A	AA
U	UU
ı	"
;	::
Q	QQ
*	**
!	;!
?	*?

Both vowel lengthening and extra pauses are used in the example below, the chorus of the AndroAnthem, which can be sung to the tune of the Lumberjack's Song.

I'm an Androbot,
;I 3M,5 AN AA3 H DRO B;T,5

and I'm OK
AND, I3 H,5 O3 ,5 K@3 ,7

I charge all night,
I, C;3 RJ,4 *L,3 N;I3 T,5

and I work all day.
AND I, W'EK,4 *L,3 D@3 ,7

FOREIGN LANGUAGES

You can make TOPO speak languages other than American English by using the PHON" command. (You can also use the SAY" command, but you will probably want to adjust the intonation using the methods available with PHON".) TOPO will, of course, have a very American accent, since it can use only English sounds, strung together in an English rhythm. TOPO's pronunciation of the foreign language will sound better or worse largely depending on how many foreign sounds are missing from its repertoire.

For example, the consonant at the end of German 'ich' cannot be pronounced in the German way, and you will have to substitute a 'k', as do many American speakers of German.

Here are some examples of TOPO's multi-lingualism, as spoken with PHON":

French:

BON X 9<QR-R ,6 XQ M"" PEL T 70 P 20 [R]

German:

G6: TEN T 7<;K ,3 M/N N;3 ME ,3 IST , T 803 P 20 [R]

Spanish:

9* L 2; ,5 N 7& H 9*M BR 5E , ES T 70 P 20 [R]

Italian:

C#3 ,7 MM 5&3 , K 7Y; M 40 T 70 P 20 [R]

Chinese:

N& E# ,7 W* SS 7Q1 , TO PO [R]

Japanese:

H; J 8&1 M# M; \$T 1E ,5 T 80 P 20 D 2ESS [R]

Arabic:

M 8;RR H; B;N ,8 7A N 5A ,3 7IS , M& ,2 T 90 P 20 [R]

Section 6

FOR PROGRAMMERS

"Klaatu barada nikto!" (Gort, the robot, had the power to destroy the earth - unless held in check by these mysterious words)

*-The Day the Earth Stood Still
•1951, 20th Century Fox*

INTRODUCTION

Section 1 of this manual includes a list of suggested reading material to familiarize you with the FORTH programming language. We recommend that you learn FORTH before continuing with this section. If you use the book STARTING FORTH you will need to refer to our list of exceptions in the APPENDIX section of this manual. As you become more familiar with FORTH, you will become more aware of the many types of operations you can devise for TOPO.

Many TOPO owners will enjoy controlling their robot even with little or no previous programming experience. We are certain, however, that many of you are programmers, or have computer experience and are interested in making TOPO realize its full potential.

This section is for you.

ABOUT TOPOSOFT

TopoSoft is a FORTH-based application program. It adheres very closely to the

FORTH-79 Standard, and is written for ease of portability to other computer systems.

You are encouraged to investigate the source code on the TopoSoft diskette to better understand TopoSoft and to familiarize yourself with the techniques and style used in developing the program.

The TopoSoft diskette starts with screens consisting of the boot image. Other screens include the MVP FORTH utilities source code, including the editor, assembler and other useful words, and the TopoSoft source code.

Screen #139 is an index of all the screens on the TopoSoft diskette.

To study the source code, you should first copy the entire TopoSoft diskette and use the copy only. Save the original TopoSoft diskette in a safe place to avoid loss or damage.

If you have a computer with only a single disk drive, use the existing DOS disk copy routine, or any other convenient disk copy program.

To quickly copy the TopoSoft diskette with two disk drives, first boot your computer with TopoSoft. Then, initialize a blank diskette with INIT-DISK, as described in Section 2.

To copy the TopoSoft diskette onto the initialized diskette, insert the TopoSoft diskette in disk drive #1 and insert the initialized diskette in disk drive #2. Then, type the command

COPY-DISK **R**

After the messages

READS DRV1

WRITES ON DRV2

DO YOU MEAN IT (Y/N)?

appear on the monitor, type

Y

and the computer will copy the TopoSoft diskette onto the initialized diskette.

ADDITIONAL TOPO COMMANDS

Earlier sections of this manual presented commands for controlling TOPO's movement and speech. There are more commands, however, intended for those who wish to write more complex programs for TOPO.

These commands, their purpose and examples of how to use them are presented below.

STATUS REQUEST COMMANDS

The GET-POSITION command places on the stack the angle and distance TOPO has covered since the start of the currently executing motion command. If TOPO is not moving, the final position from the last position command is returned. (The value is cleared by RESET-MOTION, or at the start of a new motion).

Here is an example using the GET-POSITION command: enter the command

720 100 TMOVE [R]

and, while TOPO is moving, enter the commands

GET-POSITION . . [R]

This will get the current position and print the stack (top item first). If TOPO had just completed one turn, you would see values of approximately 50 360.

The GET-VELOCITY command places on the stack the current actual angular velocity (in degrees/sec) and linear velocity (in cm/sec) of TOPO. For example, enter

50 SKT-SPEED 300 BACK [R]

While TOPO is still moving, enter

GET-VELOCITY . . [R]

This will get TOPO's current velocity and print the stack (top item first). The values should approximate -50 0 since TOPO is moving backward at 50 cm/sec with no angular velocity.

The GET-HEADSWITCH command returns a single value on the stack, between 0 and 30. This five-bit number has one bit set or not set for each of the four headswitches. The least significant bit (bit 0) is not used and is always 0. Bit 1 corresponds to switch #1; bit 2 to switch #2; bit 3 to switch #3 and bit 4 to switch #4.

An "ON" bit means that that switch has been pressed. For example, a value of 16 (10000) means that switch #4 has been pressed. A value of 12 (01100) means that switches #2 and #3 have been pressed, and a value of 0 (00000) means that no switches have been pressed.

TOPO's headswitches are latched, which means that you can determine if a switch was pressed even if you do not perform a GET-HEADSWITCH command until after the switch was released. A GET-HEADSWITCH also resets the latch, so all further requests will return 0's until a switch has been released and is pressed a second time.

If TOPO is still in HEADFOLLOW mode, you will probably want to DISABLE-HEADFOLLOW before writing routines using the headswitches. Remember that TOPO will then stop automatically whenever you press any headswitch.

For example, the following commands will read the headswitches and make TOPO say "hello" whenever any switch is pressed. TOPO will do this until switch #4 is pressed.

```
: HELLO BEGIN GET-HEADSWITCH DUP  
IF SAY" HELLO" THEN  
16 AND UNTIL SAY" BYE BYE" ; R
```

The SPEECH-FULL? command returns a true on the stack if TOPO's on-board speech buffer is full. Using FORTH conventions, 0 = false, and any other value = true. This command is only needed if you are worried about overflowing the speech buffer. It holds 1700 bytes, or more than one minute of normal speech, so an overflow should rarely, if ever, occur.

The TALKING? command returns a true on the stack if TOPO's speech board is currently speaking. Note that a significant pause between words can result in a temporarily false TALKING? condition.

An example of how to use TALKING? is our implementation of TILL-SILENT, shown below:

: TILL-SILENT BEGIN TALKING? NOT UNTIL ; R

The TOPO-ON? command returns a true on the stack if TOPO is responding on the currently active channel (see MULTIPLE TOPO CONTROL in this section for an explanation of channels). TOPO-ON? returns a false if no TOPO is responding on the current channel.

Note that "public" channels (see MULTIPLE TOPO CONTROL) will always result in a false, since no responses are ever given to public channel messages.

MORE ON MOTION CONTROL

The GO-FOREVER command will cause TOPO to start moving at a given turn rate and linear velocity, and to keep moving in that manner until another command is received. GO-FOREVER expects an angular velocity (in deg/sec) and a linear velocity (in cm/sec) on the stack, with linear velocity on top (entered last).

CAUTION

EXERCISE EXTREME CAUTION WHEN USING THE GO-FOREVER COMMAND. TOPO WILL CONTINUE MOVING ON THE SAME PATH UNTIL ANOTHER COMMAND IS RECEIVED, OR UNTIL TOPO PASSES OUT OF RANGE OF THE BASE COMMUNICATOR.

GO-FOREVER is a "do forever" command, which is sometimes useful if you know what you are doing. For example, to make TOPO slowly turn right in place, enter

50 0 GO-FOREVER [R]

To order a fast, tight circle, enter

100 30 GO-FOREVER [R]

To move slowly backward (forever, remember, so be careful out there), enter

0 -5 GO-FOREVER [R]

MULTIPLE TOPO CONTROL

Most TOPO owners will control only one TOPO at a time. TopoSoft, however, will allow you to control up to 16 TOPOs independently.

Every command sent from the base communicator contains a channel number, directing which TOPO or TOPOs should respond to the command. There are 16 "private" channels (numbered 0-15), and four "public" channels (numbered P1-P4). First,

we will discuss the private channels.

TOPO is set at the factory with a default channel number assignment of channel #0. TopoSoft automatically sends commands over channel #0 unless instructed to do otherwise, so single-TOPO operations work correctly.

Two commands allow you to change these default values. The command OPEN-CHANNEL instructs the base communicator to send all subsequent commands to TOPO over the new channel. For example, the command

3 OPEN-CHANNEL [R]

will cause all further TOPO commands (SAY", ARC, etc.) to be sent over channel #3, and the command

0 OPEN-CHANNEL [R]

will cause all further commands to be sent over channel #0, the default condition after turning on the base communicator.

After you change the base communicator's channel number with an OPEN-CHANNEL command, a TOPO on the old channel will be unresponsive to commands.

The command CHANGE-CHANNEL will instruct TOPO to respond to commands on the new, private channel n.

For example, after you turn on both TOPO and your computer, the base communicator will send commands to TOPO over channel #0, and TOPO will respond to those commands.

But, if you type the command

3 CHANGE-CHANNEL [R]

TOPO will respond to commands sent over channel #3, and will not respond to commands from the base communicator until you change the base communicator's channel number to correspond to TOPO's channel number. To do this, type the command

3 OPEN-CHANNEL [R]

which will change the base communicator's channel number to channel #3.

(Note the order of CHANGE-CHANNEL and OPEN-CHANNEL. If you ordered an OPEN-CHANNEL first, TOPO would never receive the CHANGE-CHANNEL command).

These commands are useful when you want to control two TOPOs independently.

You cannot turn on more than one TOPO at the same time, since both will be responding to the default channel #0, and the base communicator will not be able to distinguish responses from a particular TOPO.

To solve this problem, turn on the first TOPO and type the command

1 CHANGE-CHANNEL [R]

This TOPO will now respond to commands only on channel #1.

Then, turn on the second TOPO. It will be in the default condition, and will respond only to commands sent over channel #0, while the first TOPO will respond only to commands sent on channel #1. Now you can use OPEN-CHANNEL to talk to either TOPO.

This technique can be extended for up to 16 TOPOs.

In addition to the 16 private channels, messages can be sent to TOPOs over four public channels, labeled P1, P2, P3 and P4. To send a command over a public channel, use the OPEN-CHANNEL command as with private channels. For example, the command

P1 OPEN-CHANNEL [R]

will route all further commands over channel P1 until changed to a private channel or a different public channel.

Public channel P1 is an "all-call" channel. This means that all TOPOs within range will respond to commands sent over channel P1, regardless of their channel assignments.

Channels P2, P3 and P4 are programmable public channels, which means that any designated TOPO can be programmed to respond - or not respond - to commands sent over these channels.

The command

n ENABLE-PUBLIC [R]

directs the currently addressed TOPO(s) to respond to commands sent over public channel n (P2-P4 only).

Similarly, the command

n DISABLE-PUBLIC [R]

directs the currently addressed TOPO(s) to ignore commands sent over the designated public channel.

All TOPOs have a power-on default setting of P2-P4 disabled (remember that P1 is always enabled and cannot be disabled).

The following scenario demonstrates how you can control multiple TOPOs with these commands.

Imagine a room with four active TOPOs, individually assigned to private channels 1, 2, 3 and 4. To make all four TOPOs say "Hello" in unison, type the commands

P1 OPEN-CHANNEL SAY" HELLO" R

To make only TOPOs 1 and 3 say "Hello" in unison, type the commands

1 OPEN-CHANNEL P2 ENABLE-PUBLIC R

3 OPEN-CHANNEL P2 ENABLE-PUBLIC R

P2 OPEN-CHANNEL SAY" HELLO" R

To reset public channel P2 for all four TOPOs, type the command

P1 OPEN-CHANNEL P2 DISABLE-PUBLIC R

At this point, some considerations on using public channels must be mentioned.

Public channel P4 may be automatically enabled or disabled for JOYSTICK or other system functions, so it should be used only with caution.

Since public channels are usually directing messages to more than one TOPO, any message requiring a response would probably result in two or more TOPOs answering simultaneously,

so both messages would be garbled. To avoid this garbling, TOPOs are programmed to listen, but never to send any responses to public messages. This has two effects:

1. Status requests from TOPO (GET-POSITION, TILL-STOPPED, TALKING?, etc.) will have no effect when sent over public channels, since no answer will be sent.
2. Public channel messages are not as reliable as those sent over private channels, since the system has no way to verify that the message was properly received by all TOPOs.

If reliability is a concern, there are several alternatives to public channels for controlling multiple TOPOs.

Consecutive motion commands to individual TOPOs will cause the robots to be activated nearly simultaneously.

For speech commands, try sending SAY-LATER" commands to all individual TOPOs, then a SAY-IT command (or, to ensure reception, several SAY-IT commands) over the public channel.

Appendix A

TROUBLESHOOTING

ERRORS DURING SYSTEM START-UP

PROBLEM

PROBABLE SOLUTION

Disk Drive
not spinning

1. Check electrical connections:

Power off the computer and all externally attached devices (printer, etc.).

Check the wall outlet by plugging in a lamp.

Is the disk drive connected properly?

Disk drive
will not
stop spinning:

1. Is the TopoSoft diskette inserted in the disk drive (with the label facing up and toward the front of the disk drive)?
2. Is the disk drive door closed?

PROBLEM

PROBABLE SOLUTION

No visible display on monitor:

1. Is monitor connected to the computer?
2. Is monitor brightness control adjusted properly?
3. Is monitor power connected?

Error message is displayed on monitor:

"SERIAL CARD NOT FOUND IN SLOT #2"

1. Turn off the computer and check for proper Super Serial Card installation.
2. If you are determined to leave the card where it is - in slot #5, for example, enter the command

5 SETUP-SERIAL-SLOT [R]

(use SAVE-FORTH to save this new configuration).

PROBLEM

PROBABLE SOLUTION

Error Message
is displayed
on monitor:

"INVALID BASE COMMUNICATOR RESPONSE"

1. Is base communicator red power indicator light (in middle of center red panel) illuminated? If not, is base communicator power supply (smaller black box) properly connected?
2. Is base communicator cable properly connected at both ends?
3. Is serial card connector plugged into serial card?
4. Are serial card switches correctly configured? (See Section 2 for configuration instructions).
5. Is serial card jumper block properly installed? (See Section 2 for instructions).

PROBLEM

PROBABLE SOLUTION

Error Message:

"TOPO NOT RESPONDING"

1. Is TOPO turned on?
2. Is battery status light on TOPO's back control panel GREEN? If light is RED, batteries need recharging.
3. Are there any obstructions between TOPO's headswitch and the base communicator?
4. Is TOPO within range of the base communicator?
5. Has TOPO been reconfigured by the previous user? Turn TOPO off, then on again.

TOPO's lights are off while battery is being charged:

1. Is proper power supply (large black box) plugged in correctly?

Appendix B

TOPOSOFT COMMAND SUMMARY

All TopoSoft commands are listed below, followed immediately by their "stack effect" (whether any numbers are consumed or generated by the command). Numbers before the -- are removed from the stack and used by the command. Numbers after the -- are placed on the stack by the command. Commands with no effect on the stack are shown simply as (--).

DIRECT MOTION COMMANDS

JOYSTICK (--)

Initiates real-time joystick control. Terminated by pressing any key or button.

FWD (distance --)

Move forward "distance" (in centimeters).

BACK (distance --)

Move backward "distance" (in centimeters).

LEFT (angle --)

Turn left in place "angle" (in degrees).

RIGHT (angle --)

Turn right in place "angle" (in degrees).

ARC (angle, distance --)

Move over a (generally) curved path of "distance" (in centimeters) forward while turning "angle" (in degrees) to the right. Negative values have the reverse effect.

CO-FOREVER (turnrate, speed --)

Directly execute the given turn rate (in degrees/second) and speed (in centimeters/second) and maintain until another direct motion command is received. Use only with caution.

PARK (--)

Stop TOPO and cancel the currently executing motion command(s).

MOTION PARAMETER CONTROL COMMANDS

SET-SPEED (speed --)

Set the target velocity (in centimeters/second) to be used with subsequent motion commands.

SET-RAMP (acceleration --)

Set the acceleration/deceleration ramp (in centimeters/second²) to be used with subsequent motion commands.

MOVE-EXACT (--)

Cause subsequent consecutive motion to come to a full stop between commands for more precise distance control.

MOVE-SMOOTH (--)

Cause subsequent consecutive motion commands to blend together for smoother motion. This is the default setting.

RESET-MOTION (--)

Resets all motion parameters to their power-on values. Also causes TOPO to stop, and aborts any currently executing motion commands.

MOTION STATUS-RELATED COMMANDS

TILL-STOPPED (--)

Wait until all motion commands are completed before continuing command processing.

GET-POSITION (-- angle, distance)

Get the elapsed angle and distance covered so far by the latest motion command.

GET-VELOCITY (-- turnrate, speed)

Get the current turn rate (in degrees/second) and speed (in centimeters/second).

HEADSWITCH COMMANDS

GET-HEADSWITCH (-- byte)

Returns a true for each headswitch pressed since the last request. The return byte (D0-D7) uses bits D1-D4 for headswitches 1-4. The other bits are set to 0 (not used).

ENABLE-HEADFOLLOW (--)

Enable HEADFOLLOW mode using TOPO's headswitches. This is the default setting.

DISABLE-HEADFOLLOW (--)

Disable any automatic motion using TOPO's headswitches. TOPO will now stop when any headswitch is pressed. Headswitches can still be read with GET-HEADSWITCH.

DIRECT SPEECH COMMANDS

SAY" (--)

Speak the following text string until delimited by a closing quotation mark.

PHON" (--)

Speak the following phonetic codes until delimited by a closing quotation mark.

SAY# (number --)

Speak the digits of the given number.

DEFERRED SPEECH COMMANDS

SAY-LATER" (--)

Load the following text into the speech module, but do not speak it yet. Speech will be activated by any speech command, except: TILL-SILENT, TALKING?, SPEECH-FULL?, RESET-SPEECH or another SAY-LATER."

SAY-IT (--)

A convenient command to activate SAY-LATER" speech.

CONTROLS FOR PHONETIC & TEXT SPEECH

SET-PITCH (number=1 to 63 --)

Set the pitch (frequency) level for subsequent speech. 1 is the lowest pitch; 63 is the highest pitch. 20 steps equal about one octave.

SET-VOLUME (number=0 to 15 --)

Set the volume level for subsequent speech. 0 is the quietest level; 15 is the loudest level.

TALK-FAST (--)

Set the speech rate to "fast" for subsequent speech.

TALK-SLOW (--)

Set the speech rate to "slow" (normal) for subsequent speech. This is the default setting.

TALK-LEVEL (--)

Disable all pitch variation for subsequent speech.

TALK-WAVY (--)

Enable normal pitch variation for subsequent speech. This is the default setting.

RESET-SPEECH (--)

Resets all speech parameters to their power-on values. Also interrupts any currently executing speech.

CONTROLS FOR TEXT-TO-SPEECH ONLY

SAY-LETTERS (--)

Speak letter-by-letter for subsequent speech.

SAY-WORDS (--)

Speak words normally for subsequent speech. This is the default setting.

SAY-SOME-PUNC (--)

Pronounce only the special symbols:

@ # \$ % & * + = < > /
for subsequent speech. This is the default setting.

SAY-MOST-PUNC (--)

Pronounce all printed punctuation symbols for subsequent speech.

SAY-ALL-PUNC (--)

Pronounce all symbols received - including spaces, carriage returns and linefeeds.

SPEECH STATUS-RELATED COMMANDS

SPEECH-FULL? (-- flag)

Returns a true (1) if the speech buffer is full. Returns a false (0) if the speech buffer is not full.

TALKING? (-- flag)

Returns a true (1) if the speech module is currently speaking. If not, returns a false (0).

TILL-SILENT (--)

Wait until speech module is silent before continuing command processing.

CHANNEL COMMANDS

OPEN-CHANNEL (channel --)

Directs the base communicator to send all subsequent commands over the new channel. Valid channels are 0-15 (private) and P1-P4 (public).

CHANGE-CHANNEL (privatechannel --)

Directs TOPO to change its private channel assignment to the new channel. The new channel should be 0-15 (private) only.

ENABLE-PUBLIC (publicchannel --)

Directs TOPO to listen on the given public channel. No other public or private channels are affected. Valid for channels P2-P4 only.

DISABLE-PUBLIC (publicchannel --)

Directs TOPO not to listen on the given public channel. No other public or private channels are affected. Valid for channels P2-P4 only. The default setting is P2-P4 disabled.

TOPO COMMANDS

RESET-TOPO (--)

Initiate a power-on sequence on TOPO. All on-board parameters will be reset to their default values, and any current execution will be cancelled.

TOPO-ON? (-- flag)

Returns a true (1) if TOPO is responding to commands. Returns a false (0) if not. Will only work properly if sent over a private channel.

Appendix C

TOPOSOFT 6502 ASSEMBLER

A 6502 machine language assembler for use with TopoSoft is included in this implementation. It is, essentially, the assembler written by William F. Ragsdale, published in FORTH DIMENSIONS, Volume III, No. 5, and also published - with a glossary - in DR. DOBB'S JOURNAL, No. 59, Volume 6, Issue 9 (September, 1981). Reprints of these publications are available from Mountain View Press, whose address is printed in Section 1 of this manual.

The following changes to the original should be noted.

AGAIN, REPEAT, and WHILE, added to complement the existing BEGIN, and UNTIL,. Their functions are similar to those of corresponding FORTH words.

VS conditional for the overflow status bit added.

TopoSoft and the utilities, as written, can be LOADED without the assembler being resident in memory. We have LOADED the assembler in at the end, so you can FORGET the assembler if you do not need it and would like to free another 1300 bytes of memory.

FORTH EDITOR COMMAND SUMMARY

The following is a brief summary of the editor commands which are not already standard FORTH words. The TopoSoft editor (originally written by S.H. Daniel, and published in FORTH DIMENSIONS, Volume III, No. 3) is the same as the editor printed in STARTING FORTH (see Section 1 of this manual), and we recommend that book as the best source for more detailed explanations.

EDITOR (--)

Enable the EDITOR vocabulary. All of the following commands (except where noted to be in the FORTH vocabulary) will only be recognized when the EDITOR vocabulary is active. The vocabulary is disabled whenever any colon definition is compiled.

SCREEN OPERATIONS

EDIT (screen# --)

List the given screen, and enable the EDITOR. Defined in the FORTH vocabulary in TopoSoft. A handy word to avoid the frustration of forgetting to re-enable the EDITOR after a LOAD. Not shown in STARTING FORTH or MVP FORTH.

WIPE (--)

Erase the current screen. Defined in the FORTH vocabulary.

L (--)

Like the FORTH word LIST, except that the current screen number is obtained from the variable SCR, rather than being typed in by the user. Not shown in STARTING FORTH.

N (--)

(Next). Increments the current screen number by one. This command is used just before the L command, to allow the user to list the next sequential screen. Not shown in STARTING FORTH.

B (--)

(Back). Decrements the current screen number by one. This command is used before the L command, to allow listing of the previous sequential screen. Not shown in STARTING FORTH.

LINE OPERATIONS

T (line# --)

(Type). Type the indicated line from the current screen. Set the cursor to the start of the line.

P text (--)

(Put). Any following text will be copied into the INSERT buffer. The INSERT buffer will be copied into the current line, replacing its previous contents. If the text consists of one or more blanks, the current line will be erased.

U text (--)

(Under). Any following text will be copied into the INSERT buffer. Reads the screen at the line immediately below the current line, leaving a blank line. All following lines are pushed down. Any text on line 15 will be lost. The contents of the INSERT buffer will be copied into the blank line, and that line will be made the current line.

X (--)

(eXtract). Copies the current line into the INSERT buffer, and removes it from the screen. All following lines are moved up, and line 15 is left blank.

M (block#, line# --)

(Move). Copies the current line into the INSERT buffer, then copies the INSERT buffer into the block, specified by block#, UNDER the line specified by LINE#. The original block number is restored, and the next line in the block becomes the current line.

PP text (line# --)

Like P, but designates the line number into which to put text. Defined in ALL ABOUT FORTH in the FORTH vocabulary, but not shown in STARTING FORTH.

EDITING OPERATIONS

F text (--)

(Find). Any following text is copied into the INSERT buffer. The contents of the INPUT buffer are compared to the contents of the current screen, starting at the current line. If a match is found, the line is displayed with the cursor positioned immediately after the end of the string under search. If no match is found, the requested string is echoed to the terminal and the error message NONE is output.

E (--)

(Erase). Erases backwards from the cursor, according to the number of characters in the FIND buffer. This command should only be used immediately after the F command.

D text (--)

(Delete). Any following text is copied into the FIND buffer. The D command is a combination of F and E commands. The string in the FIND buffer is matched against the contents of the current line and, if a match is found, the found string is deleted.

I text (--)

(Insert). Any following text will be copied into the INSERT buffer. The I command copies the contents of the INSERT buffer into the current line, starting at the current cursor position. Any text to the right of the cursor will be pushed to the right and will be pushed off the line and lost if the total length of the line exceeds 64 characters.

R text (--)

(Replace). Any following text is copied into the INSERT buffer. The R command operates as a combination of the E (Erase) and I (Insert) commands. Starting at the current cursor position, and working backwards towards the start of the line, text corresponding to the length of the contents of the FIND buffer is deleted, and the contents of the INSERT buffer are inserted into the line. Since the contents of the FIND buffer determine how much text will be erased, the R command should only be used immediately following the F (Find) command.

TILL text (--)

(Till). Any following text is copied into the FIND buffer. Starting from the current cursor position, TILL searches the current line for a match with the contents of the FIND buffer. If a match is found, TILL deletes all the text on the line from the current cursor position up to and including the end of the matched text.

S Text (lastscreen# +1)

(Search). Any following text is copied into the FIND buffer. Starting at the top of the current screen and continuing until the bottom of the screen immediately before the screen number on the top of the stack, S searches for a match to the contents of the FIND buffer. Whenever a match is found, the line containing the match will be typed out, along with the line number and screen number in which the match occurred. Because of the way FORTH handles loops, the number on the top of the stack must be one higher than the highest screen to be searched.

^ (--)

Used as a terminator for all commands allowing text input, such as P, F, R, etc. Allows more than one command to be entered on a single line, as shown in the following example:

3 T P This is line 3 ^ L R

Although useful, this feature does preclude the use of the ^ as a character in any text to be put on the screen.

ERROR MESSAGES

NONE

The searched-for string was not found.

NOT ON CURRENT EDITING SCREEN

Invalid line number given.

DRV1, DRV2, DRV3, DRV4, DRV5 (--)

Equivalent to MVP FORTH words DR0 through DR4, but more consistent with Apple computer disk drive numbering. Sets the screen offset so that any screen access 0 through 139 will use the specified disk drive.

SAVE-FORTH (--)

SAVE-FORTH is now vectored through 'SAVE-FORTH to call <SAVE-FORTH>.

The following words referenced in ALL ABOUT FORTH are not implemented in MVP FORTH V1.0103.03 for the Apple computer. They consist, basically, of useless 8080 and CP/M disk-related functions:

'T&SCALC, <T&SCALC>, DISK-ERROR,
DPUSH, DRIVE, HPUSH, NEXT1, RPP,
SEC, SEC-READ, SEC-WRITE, SEC/DR,
SET-DRIVE, SET-IO, SYSCALL,
T&SCALC, TRACK.

The following changes to MVP FORTH V1.0103.03 were made in creating TopoSoft:

2/ function was replaced (it was missing from MPV FORTH).

COLD was rewritten with new TopoSoft boot message. Also, COLD was fixed to call ABORT, not <ABORT>.

DMIN utility was fixed to provide the correct polarity result.

RP> in the assembler changed to RP) to conform to the original assembler documentation.

.S utility default was changed to print top of stack on the right.

CALL utility was rewritten to facilitate loading without using the assembler.

TITLE utility was rewritten with the TopoSoft message.

The GRAPHICS vocabulary was deleted.

Reassembled leaving only one hi-res graphics page (page 2).

CREATE fixed to look for boundary at FF, not F.

CORRECTIONS TO STARTING FORTH

For use with TopoSoft/MVP FORTH for the Apple II+ and Apple IIe computers.

This list will enable a STARTING FORTH reader to learn FORTH using currently available MVP/TopoSoft FORTH Systems. STARTING FORTH is an excellent tutorial, but is written for a different dialect of FORTH (PolyFORTH) than we are using. This list was generated by working through STARTING FORTH on an Apple II+, but using a TopoSoft system and noting all differences that would trap the novice user.

Note: Toposoft/MVP FORTH is based on the 1979 FORTH Standard, the most widely accepted and documented version of FORTH available.

Chapter 1

- Page 11 Examples given assume an 80-column display. If you have a 40-column display, some examples will wrap around to the next line.
- 16 We use 79-Standard, which allows up to 31 character names. Additional characters are allowed, but are ignored.
- 25 Our "stack empty" error will not print the extraneous zero.

Chapter 2

Page 50 We have `.S` already implemented, so the given definition is not needed. It also won't work as defined - replace `S0` with `SP0` instead. Also, our `.S` will not print the extraneous zero.

52 `2SWAP`, `2DUP`, `2OVER`, and `2DROP` will work, but we prefer the words `DSWAP`, `DDUP`, `DOVER`, and `DDROP` to avoid confusion with the quantity 2. Both sets are implemented.

Chapter 3

Page 60 The word "screen" is often used interchangeably with the word "block."

61 Apple II+'s and IIe's have blocks 0-139 on drive 1 and blocks 140-279 on drive 2.

61 Block 0 cannot be `LOADed`, so it is generally not used.

62 Make it a habit to `ALWAYS` put a stack comment right after the name you are creating.

This small amount of extra typing will be well worth it. Also, be sure to put the space after the `(`.

63 The single-letter editor commands (plus `TILL`) must be enabled by typing the word `EDITOR` first.

EDITOR must also be re-typed after any colon definition has been compiled. The word EDIT is a convenient way to avoid this nuisance. If not already on your system, it is - : EDIT (n --) LIST [COMPILE] EDITOR ; Use EDIT whenever you want to LIST a block, and it will automatically enable the EDITOR vocabulary as well.

**Apple II+ users: use the right-arrow key for [and shift-M for].

77 Should be "Make it a habit to FLUSH before every COPY"

77 S will find all occurrences, not just the first.

83 DEPTH and .S already implemented. Example will not work as shown.

84 Here are several additional useful word in MVP FORTH:

THRU (from, to --) Load blocks consecutively over the range from, to. Interrupt by pressing any key.

INDEX (From, to --) Print the first line of every block over the range from, to. Pause by pressing any key. Resume by pressing any key, or abort by pressing two keys in rapid succession.

VLIST (--) List the contents of the dictionary, starting with the most recent entry. Pause by pressing any key. Resume by pressing any key,

or abort by pressing two keys in rapid succession.

Chapter 4

Page 101 Our 79-Standard ABORT" marks the offending word with ^^^, but does not print it.

102,103 Our 79-Standard ?STACK does not return a flag, but automatically calls ABORT" if a stack error exists.

Chapter 5

Page 110 In place of I, we prefer to use R@ instead. I, I', and J should be used only inside of DO loops.

Chapter 6

No corrections.

Chapter 7

Page 164,
182 , / - : are not allowed as double-number indicators. Only a single . is allowed as a double-number delimiter. The variable DPL saves the count of places after the decimal point.

169,170,
171,178 Our 79-Standard SIGN uses the top of the stack (and consumes it).

Replace SIGN with ROT SIGN in all examples given.

173,179 D> is also included.

174 We allow double-numbers inside definitions.

179 Typo, second DUK should be:
D. (d --) Prints the signed 32-bit
...

Chapter 8

191 Do not use SHUTTER as specified.
It could cause your system to crash.

193 We prefer DVARIABLE, D!, D@,
and DCONSTANT instead.

194 We allow double-numbers inside
definitions.

204 A better version of DUMP is already
implemented.

Chapter 9

216,217 You MUST perform the word CFA
before you EXECUTE a value
returned by ' , thus
' GREET CFA EXECUTE

216 -' is not implemented in MVP
FORTH.

- 217,
218 Standard usage saves the CFA, thus 'HELLO CFA 'ALOHA ! and then, 'ALOHA @ EXECUTE
- 218 ' behaves differently in a colon definition; see STARTING FORTH Appendix 3. In these examples, replace ' in SAY with [COMPILE] ' COMING and GOING will work as is, or replace ['] with '.
- 219 We use <NUMBER> instead of (NUMBER).
- 223,246 EXECUTE expects a cfa (code field address or code pointer), not a pfa.
- 236,237
240,247 In our implementation, the non-standard STARTING FORTH variable S0 is named SP0. Our 79-Standard word S0 is defined as SP0 @
- 236,240,
247 A different variable TIB contains the starting address of the input message buffer.
- Chapter 10
- 258,271,
272,276 Replace S0 with TIB
- 276 An additional word BMOVE acts just like CMOVE or <CMOVE but always works correctly even if the ranges involved overlap.

268 KEY works the same, but will not echo the character.

269 WIPE already exists, but K won't work as is. Use:

```
: K FIND-BUF PAD 80 MOVE  
INSERT-BUF FIND-BUF 80 MOVE  
PAD INSERT-BUF 80 MOVE ;
```

270 The carriage-return key is received as a value 13.

277,278
285

Our definition of NUMBER is different - it always returns a double-number, and it only recognizes a leading - or an imbedded . but not :,- /
In the PLUS example, insert DROP after NUMBER.

Chapter 11

301 For (DO) or 2>R, we use <DO>

303 For (LITERAL), we use LIT

306 In our implementation, it is OK to hit a carriage-return in the middle of a definition.

311 We allow double-numbers inside definitions.

SHORTENING TOPOSOFT COMMANDS

The TopoSoft commands presented in this manual were chosen using clarity, precision and consistency as the primary considerations. We realize, however, that having very short names sometimes offers a number of advantages, especially where children or novice computer users are involved.

Fortunately, it is very easy to create alternate, short-form names or abbreviations in FORTH. For example, if you prefer the short word JOY instead of JOYSTICK, simply create the colon definition:

```
: JOY JOYSTICK ; R
```

Now, you can use either word.

If you create new, short commands and do not want to re-enter them every time you use TOPO, be sure to save them with SAVE-FORTH. Better yet, save the source code with the editor so you can LOAD them easily, and so you can look up a definition if you forget it.

Three speech commands (SAY", PHON" and SAY-LATER") are defined as FORTH "immediate" words, so renaming them is a bit trickier. For example, here is how to rename PHON" to PHONETIC":

```
: PHONETIC" [CONPILE] PHON" ; IMMEDIATE R
```

If you rename TopoSoft commands, be sure to make your command names clear and easy to understand. TopoSoft commands usually start with verbs, because the TopoSoft commands do things. Nouns are appropriate for storage locations in memory, and this distinction will be more important when you start writing fancy programs for TOPO. Also, you should be careful not to use names that are already used in TopoSoft, because you will no longer be able to use the original words.

When creating short, alternate names, there are several possible approaches.

Many programmers, and several operating systems (such as UNIX), create abbreviations by using the first letter of each sub-word. Thus SET-PITCH becomes SP, and TALK-WAVY becomes TW. This creates very short names which still preserve the functional form of the original command. The obvious disadvantage is that the resulting names are often cryptic to anyone except (and sometimes including) the original creator.

A second approach is to use short, real words which are suggestive of the original command or function. Examples would be PITCH for SET-PITCH, or WAVY for TALK-WAVY. The advantage is that names will still make sense to anyone learning them. The disadvantage is a loss of clarity (whether PITCH, for example, means set the pitch, get the latest pitch, or is just a variable named PITCH).

Although short names are sometimes convenient, we strongly encourage anyone actually writing programs to use the original longer names. This is important to keep your code understandable - to you or anyone else.

Appendix H

SPECIFICATIONS

The following are the electrical, mechanical and environmental specifications for TOPO and its base communicator:

PHYSICAL SPECIFICATIONS

Height:	36.5 inches
Width:	23 inches
Depth:	17 inches
Weight:	40 lbs.
Color:	Ivory
Materials:	ABS plastic body; steel base
Speed:	1 to 50 centimeters/second
Turn rate:	1 to 100 degrees/second
Turning radius:	Turns in its own width
Drive system:	Independent DC motors and gearboxes

MAINTENANCE

Battery charging from a standard wall outlet. No other maintenance required. Wash only with mild soap and water.

ELECTRICAL SPECIFICATIONS

Electronics:	On-board microprocessors communicate with the computer by way of infrared signals
Power:	120 VAC for battery charger
Batteries:	Two 5.5 Amp hour Gel electrolyte, sealed rechargeable. LED indicates if batteries need recharging
Battery time:	Three hours, depending on use
Battery charger:	24 VAC; 20 VA
Base communicator power:	12 VAC; 10 VA
Maximum range:	25 feet
Software:	TopoSoft diskette for use with Apple II+ or IIe included
Voice:	LPC-allophone-based text-to-speech system
Control:	By keyboard command, program or joystick

ENVIRONMENTAL SPECIFICATIONS

Storage
temperature
range: -4°F to 117°F
 (-20°C to 47°C)

Operational
temperature
range: 50°F to 104°F
 (10°C to 40°C)

NOTE: TOPO will feel comfortable
 where you feel comfortable.
 Do not put TOPO near a
 stove or fireplace, and do
 not leave it in direct
 sunlight.

Humidity: Storage and operational
 ambient: 8% - 80%

ACKNOWLEDGEMENTS

Androbot would like to acknowledge the following companies for their technological contributions to the development of TOPO:

Mountain View Press, of Mountain View, California for their assistance in modifying the FORTH computer language that serves as a basis for the TopoSoft program.

Street Electronics Corporation, of Carpentaria, California, for the Echo II Speech Synthesizer - the heart of TOPO's speech module.

The authors would also like to acknowledge the following Androbot employees for the roles they played in the development of TOPO:

Rick DeVriese (Project Manager), Ray Connell, Mike Ekberg, Linda Handor, Richard Henderson-Gragg, Doug Jones, Paul Klepak, John Krzyzanski, Julie Lovins, Yolanda Luisi, Levon Mitchell, Donna Murphy, David Oppenheim, Mike Saari, Tim Sakamoto, Sig Salat, Andy Phi, Steve Whalen, Ed Wischmeyer and Jim Young.

The original product concept and the name "TOPO" were developed by William H.T. La.

This manual was written by Michael D. Lopez and Michael J. Saari.

**ADDITIONS/CORRECTIONS
FOR TOPOSOF V1.01 12/21/83**

The following additions and corrections to the TOPO OWNER'S MANUAL were made after the manual had gone to press. We are supplying this list to ensure that you have the most complete and accurate information. These notes are listed in order by page number so you can make the appropriate notations in the margins of your manual. Then, either discard this sheet or save it for reference.

<u>Page</u>	<u>Addition/Correction</u>
Signature Edition	Footlights illuminate, they do not blink.
20	Your greeting message may show V1.01, V1.02, etc.
21	TOPO NOT RESPONDING should read TOPO#0 NOT RESPONDING.
21	Should be FORMATTING , then ERASING .
33	You may use any key for names, except the space bar, left arrow, RETURN or RESET key. Non-printing control codes will work, but are NOT recommended. The ^ key is NOT recommended because it is used by the EDITOR as a delimiter.
33	If you forget the trailing " " after a SAY" sentence in a colon definition, the error message INPUT STREAM EXHAUSTED will appear on your computer monitor.
34	Do not type RETURN in the middle of a word, or in the middle of a "string" command, such as SAY".
35	The factory speed setting is 30 centimeters/second.
36	You can alter the ramp value over a range of 1 to 100. These examples would better read 100 SET-RAMP and 5 SET-RAMP. The factory ramp setting is 10.
58	Examples may not work as shown. See next (62) example.
62	Due to a speech software anomaly, long PHON" commands may occasionally produce strange-sounding results. This can be corrected by breaking up the phrase into two shorter PHON" commands, or by inserting a ,9 delay at the beginning of the text " <u>string</u> ".
74	The command TMOVE should be ARC.
75	In the HELLO example, insert GET-HEADSWITCH DROP before the BEGIN.

ADDITIONS/CORRECTIONS

Page 2 of 3

75 The words **FWD-SWITCH?** **BACK-SWITCH?** **LEFT-SWITCH?** and **RIGHT-SWITCH?** are convenient tests for headswitch values. Each one uses an input headswitch reading value, and returns a flag. A typical usage is:

```
GET-HEADSWITCH DUP FWD-SWITCH? IF . . . THEN
DUP BACK-SWITCH? IF . . . THEN
DUP LEFT-SWITCH? IF . . . THEN
DUP RIGHT-SWITCH? IF . . . THEN DROP
```

76 A **TOPO-ON?** request on a public channel will return an error message.

76 A CASE statement word is included in TopoSoft. See the TopoSoft Utilities section for an example of how to use it.

76 The word **Q** is a quick decompiler. To find out the contents of the word "name," type:
' name Q Q Q Q . . .

82 Any status request over a public channel will return an error message.

82 The word **TEST-CHANNELS** will list a summary of all 16 private channels, showing whether any TOPO is listening on each channel.

A4 **TOPO NOT RESPONDING** should be **TOPO#n NOT RESPONDING**.

A4 Add item:

6. Be sure that the base communicator is located at least three feet away from your computer, monitor or any other electrical device.

A4 Last item should read:

PROBLEM **PROBABLE SOLUTION**

TOPO not charging properly	1. TOPO must be turned OFF while charging. 2. Battery Status Light should be ON while charging. If it is OFF, check for proper power supply and hook-up.
----------------------------	-------------------------------------------------------------------------------------------------------------------------------------------------------------

E3 The supplemental word **>TYPE** was changed to agree with the definition given in ALL ABOUT FORTH.

F3 Page 84: **VLIST** also shows the names of definitions which aborted in mid-compile. If one of these is on top of the dictionary, you can erase it by first typing **SMUDGE** and then **FORGET name**.

ADDITIONS/CORRECTIONS

Page 3 of 3

F3 Also included on Page 84 are:

PRINT-SCREENS (From, to --) Print the screens in the given range. The constant **PRINTERSLOT#** (default value of 7) defines the slot in which the printer should be connected.

--> (--) Load the next consecutive screen. This alternate to **THRU** works by having each screen call up the next screen to load.