



Ultimate Robotic Vehicle™

"URV" with Remote Control



Figures sold separately.

Model Number: 78362

Please keep this instruction sheet for future reference, as it contains important information.
Requires four "C" (LR14) **alkaline** batteries (not included). Adult assembly is required for battery installation.
Tool required for battery installation: Phillips screwdriver (not included).

Fisher-Price®

www.rescueheroes.com

BATTERY INSTALLATION

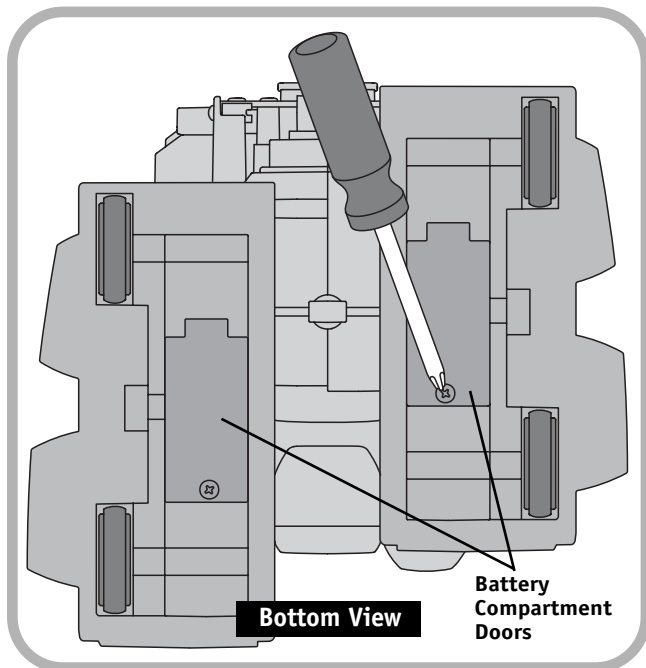

For best results, use only **alkaline** batteries.

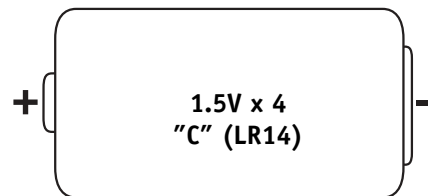

SHOWN ACTUAL SIZE

Battery Tips

- Do not mix old and new batteries.
- Do not mix different types of batteries: alkaline, standard (carbon-zinc) or rechargeable (nickel-cadmium).
- Remove the batteries during long periods of non-use. Always remove exhausted batteries from the toy. Battery leakage and corrosion can damage this toy. Dispose of batteries safely.
- Do not dispose of batteries in a fire. The batteries may explode or leak.
- Never short circuit the battery terminals.
- Non-rechargeable batteries are not to be recharged.
- Only batteries of the same or equivalent type as recommended in the "Battery Installation" instructions are to be used.
- If removable rechargeable batteries are used, they are only to be charged under adult supervision.
- Rechargeable batteries are to be removed from the toy before they are charged.
- If you use a battery charger, it should be examined regularly for damage to the cord, plug, enclosure and other parts. Do not use a damaged battery charger until it has been properly repaired.

- Locate the battery compartment door on the bottom of each foot.
- Loosen the screw in each battery compartment door with a Phillips screwdriver. Open the battery compartment doors.
- Insert two "C" (LR14) **alkaline** batteries as indicated in each battery compartment.

Hint: We recommend using **alkaline** batteries for longer battery life.

- Close each battery compartment door and tighten each screw with a Phillips screwdriver. Do not over-tighten.
- When lights, sounds or motion from this toy become faint or stop, it's time for an adult to change the batteries!

LET'S POWER UP

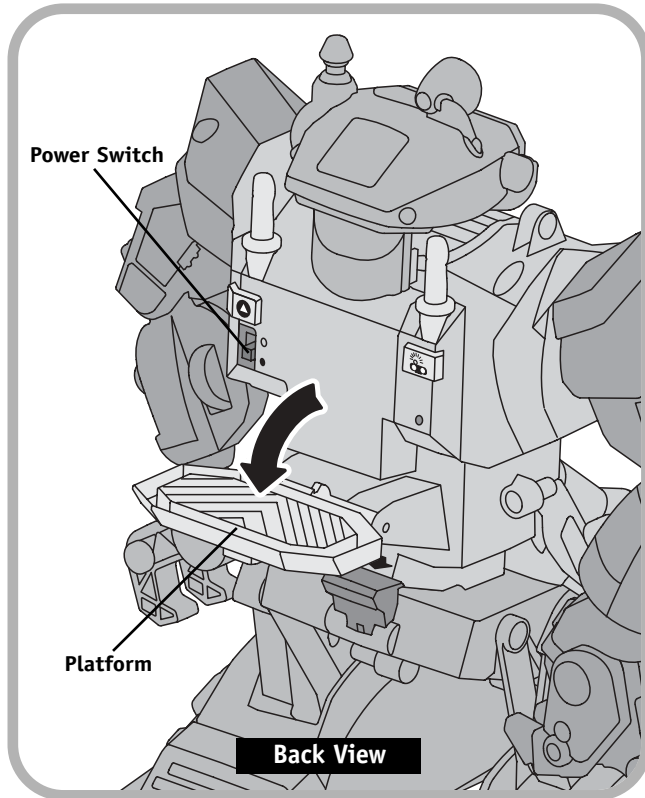

- Lower the platform on URV's back to access the power switch.
- Slide the power switch on URV's back to the on ● position.
- When turned on, URV does a "system check" testing his motors and sounds.
- When you are finished playing with URV, slide the power switch to the off ○ position.

Hint: When URV hasn't been played with for a while, he goes into "standby mode" awaiting further "commands" from the remote control. Press any button on the remote control to continue playing. If no buttons are pressed, URV shuts down. URV's lights go out and his motorized arm returns to a resting position.

LET'S MOVE OUT

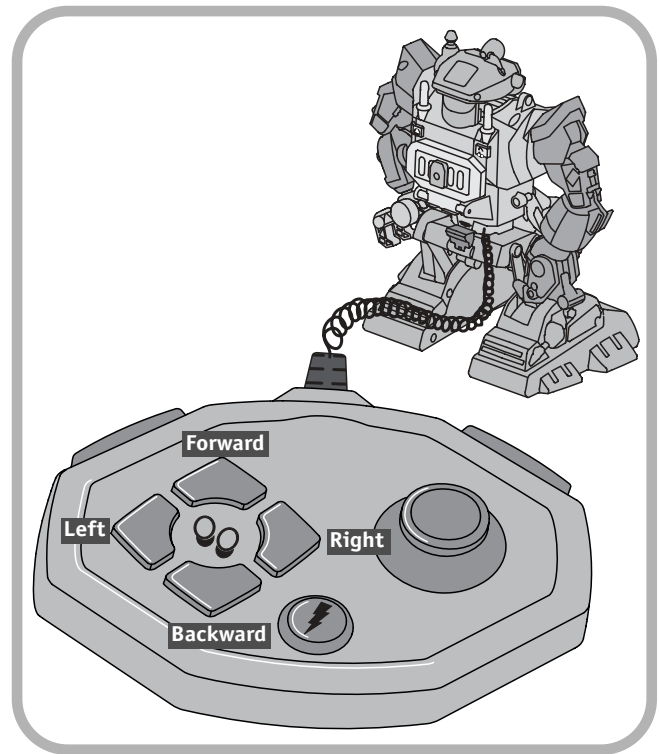

- Press the arrows on the remote control - URV walks forward, backward, left and right.

⚠ CAUTION

To prevent entanglement, keep hair away from wheels.

MOTORIZED ARM

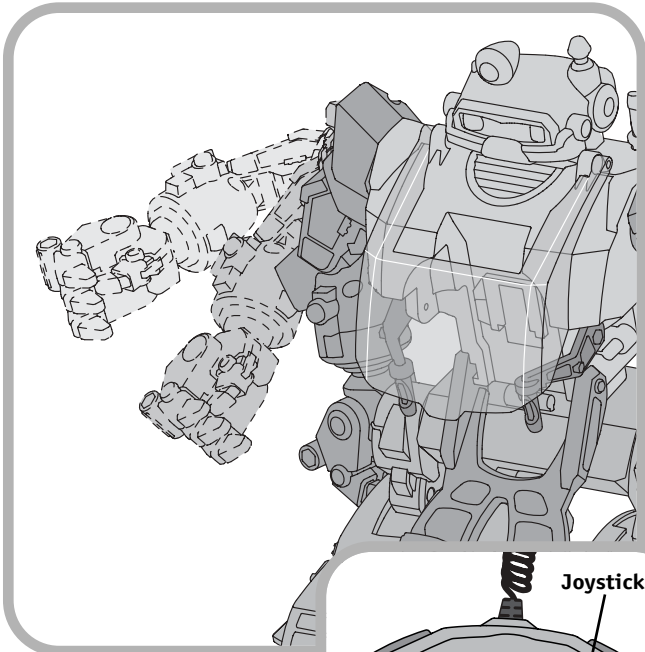

- Press the joystick on the remote control to move URV's motorized arm: up, down, in and out.

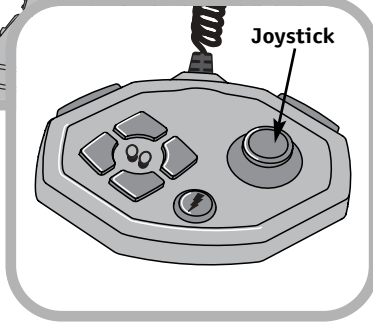

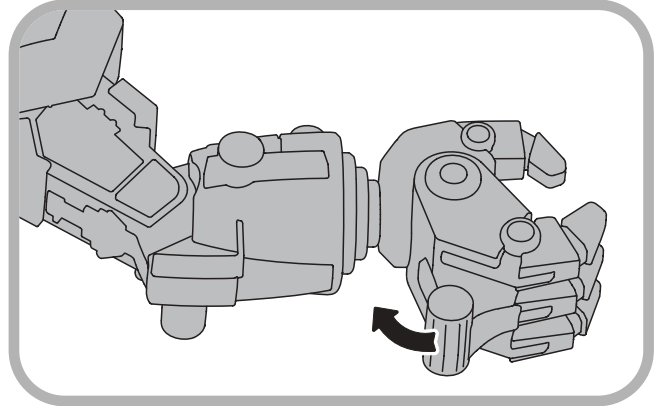

GRIPPING HAND

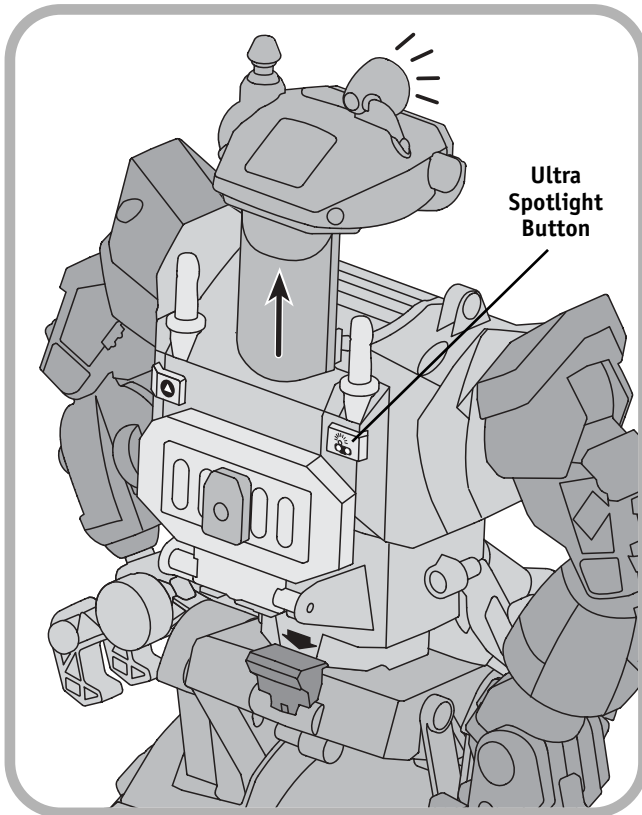

- Press the lever on the gripping hand to open it. URV can carry equipment or other Rescue Heroes™ figures in his hand.

ACTIVATING THE ULTRA SPOTLIGHT



- Press the ultra spotlight button  on URV's back. URV's head pops up and the ultra spotlight turns on.
- To turn the ultra spotlight off and to return URV's head to his standard position, press URV's head down until it clicks back into place.

ACTIVATING MAXIMUM BODY EXTENSION

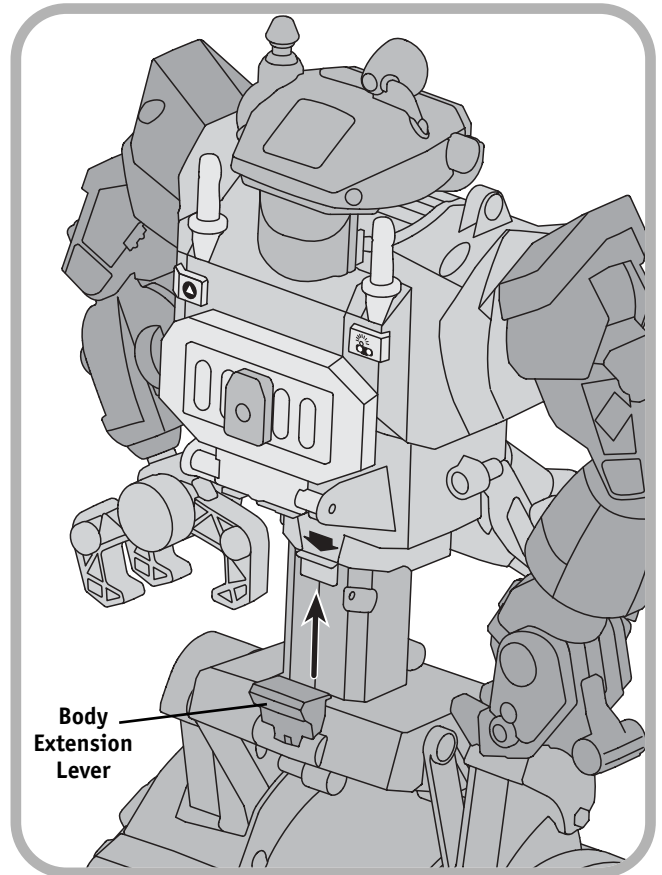

- Press the body extension lever  on URV's back. URV springs up.
- To return URV's body to his standard position, press URV's shoulders down until the body clicks back into place.

OPERATING THE WINCH

CAUTION

- Do not launch the claw at close range.
- Only use the projectile (claw) supplied with this toy.
- Do not fire at people or animals.

Press Release Button

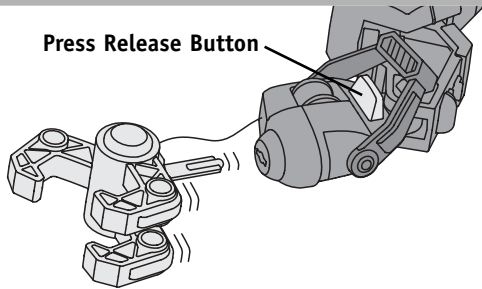

- Press the release button on URV's arm to launch the grasping claw.

Rewind Lever

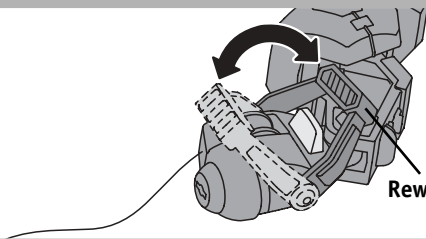

- Move the rewind lever back and forth to reel the claw back in.

Peg

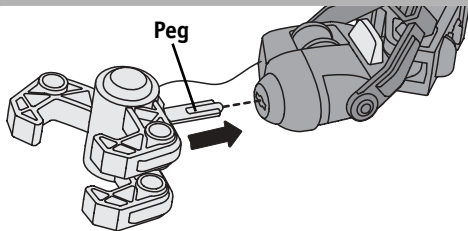

- Insert the peg on the claw into the hole in the arm. Press the claw until it "clicks" in place.

USING RESCUE HEROES™ FIGURES WITH URV

You can use any Rescue Heroes™ figure with URV, but only Voice Tech™ Rescue Heroes™ figures "talk" with URV.

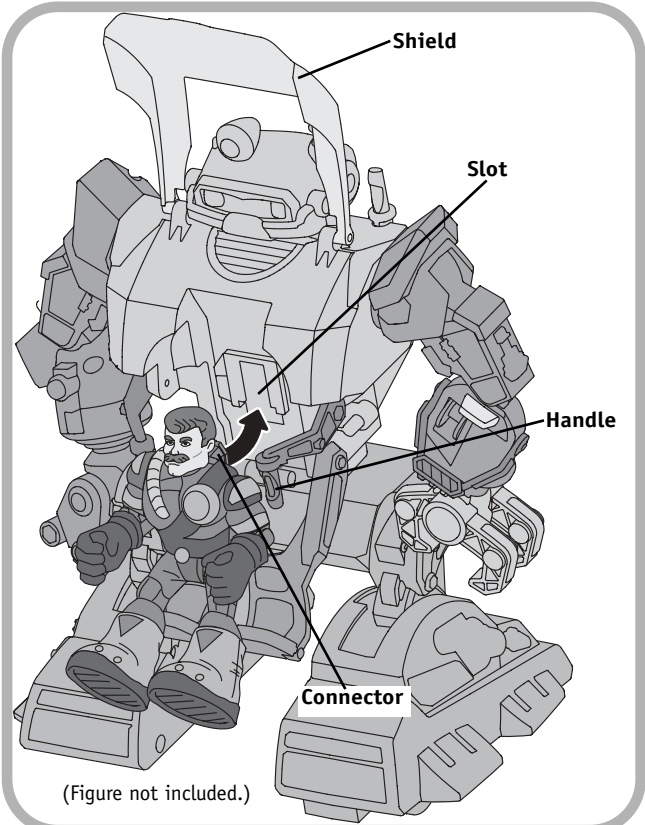





- Lift the shield.
- Slide the connector on the back of a Rescue Heroes™ figure up into the slot in URV's cockpit.

Hints

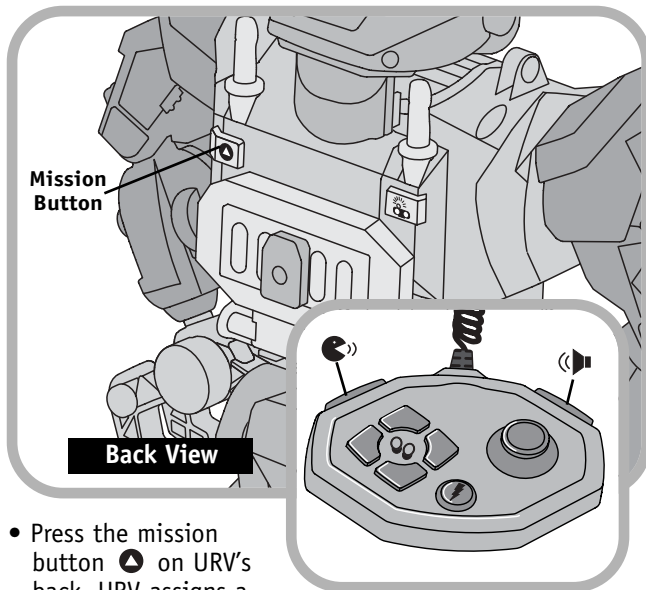



- For proper function, make sure the connector is completely inserted into the slot.
- Voice feature only works only with Voice Tech™ Rescue Heroes™ figures.
- URV recognizes that a figure is on-board and if it's a Voice Tech™ figure, URV identifies the figure by name.
- Place the figure's hands on the handles.
- Lower the shield.

USING URV WITH VOICE TECH™ FIGURES



- Press the mission button  on URV's back. URV assigns a mission to the Rescue Heroes™.
- Press the mission button  to hear the Voice Tech™ figure "talk" with URV.
- Press the speech button  on URV's remote control again and again. URV and the Voice Tech™ figure "talk" to each other.
- Press the sound effects button  on the remote control to hear robotic sounds.

OTHER RESCUE HEROES™ FIGURES

- Press the mission button  on URV's back. URV assigns a mission to the Rescue Heroes™.
- Continue pressing the mission button  to hear other phrases and missions from URV.
- Press the speech button  on URV's remote control to hear URV say different phrases.
- Press the sound effects button  on the remote control to hear robotic sounds.

RIDE ALONG

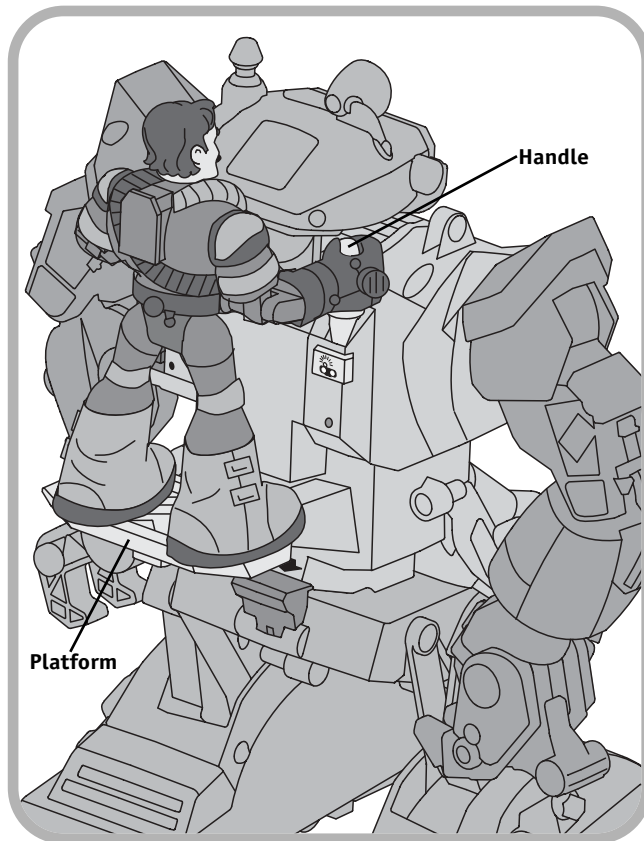

- Other figures can ride along on URV's back.
- Lower the platform on URV's back. Place a figure on the platform. Fit the figure's hands to the handles.

USING POWERMAX™ TOOLS

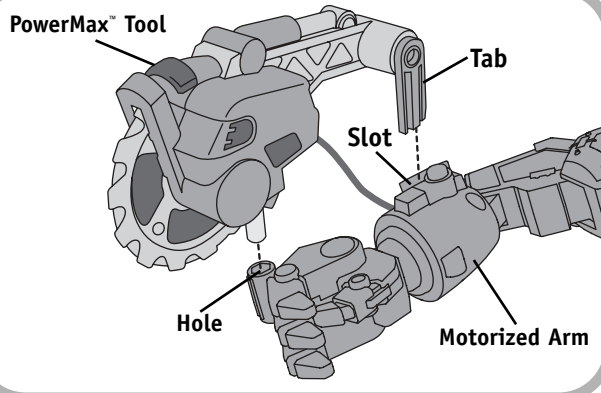
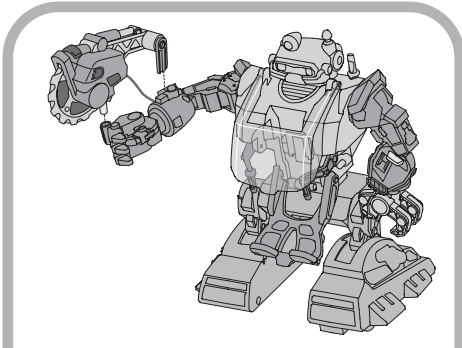

- Slide the tab on the tool arm into the slot in URV's motorized arm.
- Fit the handle on the tool into the hole in URV's hand.

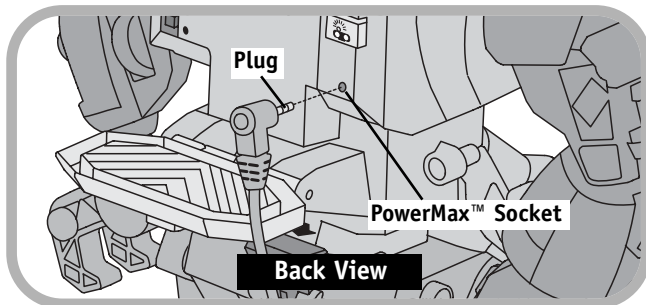

- Insert the plug from the tool into the PowerMax™ socket in URV's back.

USING POWERMAX™ TOOLS

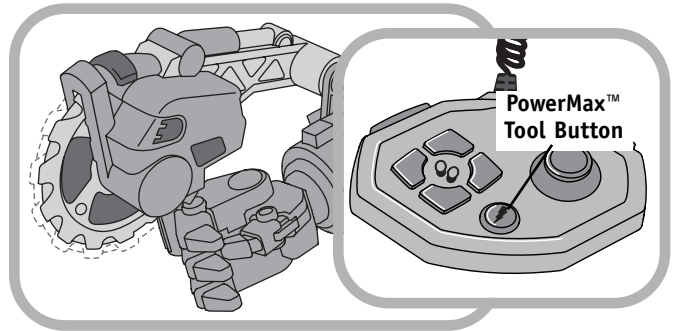

- Press the PowerMax™ tool button ⚡ on the remote control to activate the tool.

STORAGE

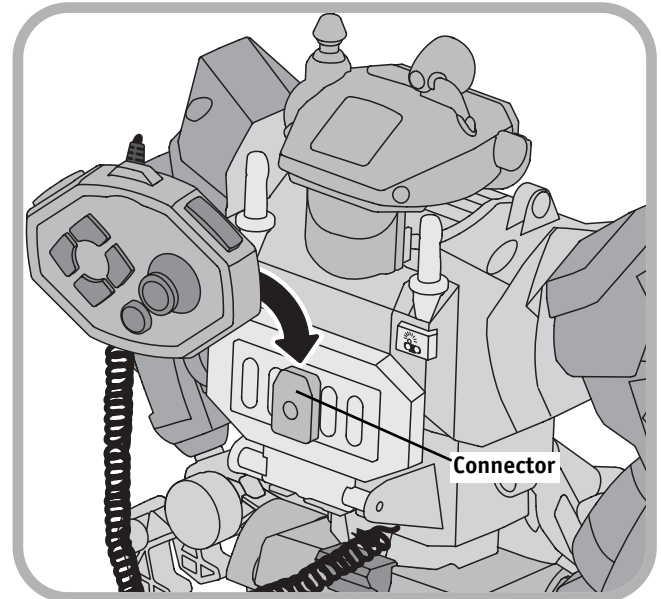

- To store the remote control, slide it on to the connector on URV's back as shown.

THE POWERMAX™ TEAM

Each sold separately and subject to availability.



PowerMax™
Jack Hammer™
78370



PowerMax™
Billy Blazes™
78371



PowerMax™
Rocky Canyon™
78371

THE VOICE TECH™ TEAM

Each sold separately and subject to availability.



Billy Blazes™
78178



Jake Justice™
78179



Wendy Waters™
78180



Jack Hammer™
78181



Rocky Canyon™
78182



Roger Houston™
78183



Matt Medic™
78184



Warren Waters™
78185



Gil Gripper™
78186



Ariel Flyer™
78187

CARE

- Wipe this toy with a clean cloth dampened with a mild soap and water solution. Do not immerse this toy.
- This toy has no consumer serviceable parts. Do not take this toy apart.
- Do not drop this toy on a hard surface.

FCC NOTE (UNITED STATES ONLY)

Note: This equipment has been tested and found to comply with the limits for a Class B digital device, pursuant to Part 15 of the FCC Rules. These limits are designed to provide reasonable protection against harmful interference in a residential installation. This equipment generates, uses and can radiate radio frequency energy and, if not installed and used in accordance with the instructions, may cause harmful interference to radio communications. However, there is no guarantee that interference will not occur in a particular installation. If this equipment does cause harmful interference to radio or television reception, which can be determined by turning the equipment off and on, the user is encouraged to try to correct the interference by one or more of the following measures:

- Reorient or relocate the receiving antenna.
- Increase the separation between the equipment and receiver.
- Consult the dealer or an experienced radio/TV technician for help.

Note: Changes or modifications not expressly approved by the manufacturer responsible for compliance could void the user's authority to operate the equipment.

CONSUMER INFORMATION

Questions? We'd like to hear from you!

Call Fisher-Price® Consumer Relations, toll-free at **1-800-432-KIDS**, 8 AM - 6 PM EST Monday through Friday. Hearing-impaired consumers using TTY/TDD equipment, please call 1-800-382-7470. Or, write to:
Fisher-Price® Consumer Relations
636 Girard Avenue
East Aurora, New York 14052

For other countries, outside the United States:

Canada: call **1-800-567-7724**, or write to: Mattel Canada Inc., 6155 Freemont Blvd., Mississauga, Ontario L5R 3W2.

Great Britain: telephone 01628 500302.

Australia: Mattel Australia Pty. Ltd., 658 Church Street, Locked Bag #870, Richmond, Victoria 3121 Australia.
Consumer Advisory Service 1300 135 312.

New Zealand: 16-18 William Pickering Drive, Albany 1331, Auckland.